

OPERATOR'S MANUAL

CADD-Prizm[®] PCS II

AMBULATORY INFUSION PUMP
MODEL 6101

*This online version differs from the
printed version.*

*Certain information that is not intended
for patients has been removed.*

This manual concerns only the Deltec CADD-Prizm® PCS II (Pain Control System) Model 6101 ambulatory infusion pump. This pump can be programmed to deliver medication at a constant rate and/or to allow delivery of a bolus dose at a specified time interval. This manual is intended for clinician use only. Do not permit patients to have access to this manual. Patient access to the pump key should be restricted. The pump has three security levels designed to limit patient access. Do not disclose the pump's security codes or any other information that would allow inappropriate access to programming and operating functions.

The issue date of this Operator's Manual is included for the clinician's information. In the event one year has elapsed between the issue date and product use, the clinician should contact Smiths Medical MD, Inc. to see if a later revision of this manual is available.

Technical Assistance

If you have comments or questions concerning the operation of the Deltec CADD-Prizm® PCS II pump, please call the number given below. When calling, please specify the pump's software module. This information is located in the pump's start-up screen.

Our staff at Smiths Medical MD is available to help clinicians twenty-four hours a day with the programming and operation of the Deltec CADD-Prizm® PCS II infusion system.

U.S. Distribution:

Smiths Medical MD, Inc.
1265 Grey Fox Road
St. Paul, Minnesota 55112 USA
1-800-426-2448 (USA)
+1 651-628-7000
www.smiths-medical.com

European Distribution:

Smiths Medical International Ltd.,
WD24 4LG UK
+44 (0)1923 246434

Read this entire Operator's Manual before operating the Deltec CADD-Prizm® PCS II ambulatory infusion pump.

Failure to properly follow warnings, cautions, and instructions could result in death or serious injury to the patient.

WARNINGS

- This Operator's Manual should be used by clinicians only. Do not permit patients to have access to this manual, as the information contained would allow the patient complete access to all programming and operating functions.
- To avoid explosion hazard, do not use the pump in the presence of flammable anesthetics or explosive gases.
- For those patients who are likely to be adversely affected by unintended operations and failures, including interrupted medication or fluid delivery from the device, close supervision and provision for immediate corrective action should be provided in order to assure minimum medication delivery interruption. Pump failure will suspend medication delivery, and unintended pump operations could lead to a variety of consequences for the patient.
- If the pump is used to deliver life-sustaining medication, an additional pump must be available, and close supervision and provision for immediate corrective action should be provided to assure minimum medication delivery interruption in the event of a pump failure. Pump failure will suspend medication delivery.
- The pump is not to be used for delivery of blood or cellular blood products, as blood and blood products will be damaged by the pumping mechanism.
- If the pump is dropped or hit, inspect the pump for damage. Do not use a pump that is damaged or is not functioning properly. Contact Customer Service to return a pump for service.
- Use of a syringe with the CADD™ Administration Set may result in UNDER-DELIVERY of medication. Syringe function can be adversely affected by variations in plunger dimension and lubricity, which can result in greater force required to move the syringe plunger. A syringe plunger will lose lubrication as it ages and, as a result, the amount of under-delivery will increase which could on occasion, be significant. Therefore, the type

of medication and delivery accuracy required must be considered when using a syringe with the CADD® pump.

Clinicians must regularly compare the volume remaining in the syringe to the pump's displayed values such as RES VOL and GIVEN in order to determine whether under-delivery of medication is occurring and if necessary, take appropriate action.

- System delivery inaccuracies may occur as a result of back pressure or fluid resistance, which depends upon drug viscosity, catheter size, and extension set tubing (for example, microbore tubing). System delivery inaccuracy may result in under- or overdelivery of medication.
- Do not administer drugs to the epidural space or subarachnoid space unless the drug is indicated for those spaces.
- To prevent the infusion of drugs that are not indicated for epidural space or subarachnoid space infusion, DO NOT use administration sets that incorporate injection sites.
- If a Medication Cassette Reservoir, CADD™ Extension Set or CADD™ Administration Set is used for epidural space or subarachnoid space drug delivery, it is strongly recommended that it be clearly differentiated from those used for other routes of infusion, for example, by color coding, or other means of identification.
- When the Air Detector is not installed, or is installed but turned off, the pump will not detect air in the fluid path. It is recommended that you periodically inspect the fluid path and remove any air to prevent air embolism.
- Follow the Instructions for Use provided with the Medication Cassette Reservoir and CADD™ Extension Set, or the CADD™ Administration Set, paying particular attention to all warnings and cautions associated with their use.
- When the Upstream Occlusion Sensor is turned Off, the pump will not detect occlusions upstream (between pump and fluid container). It is recommended that you periodically inspect the fluid path for kinks, a closed clamp, or other upstream obstructions. Upstream occlusions may result in under- or nondelivery of medications.
- Do not disclose to the patient the pump's security codes or any other information that would allow the patient complete access to all programming and operating functions.

- Ensure that the $\pm 6\%$ System Delivery Accuracy specification is taken into account when programming the pump and/or filling the Medication Cassette Reservoir. Failure to do so may result in medication in the reservoir becoming depleted sooner than expected.
- Do not use rechargeable NiCad or nickel metal hydride (NiMH) batteries. Do not use carbon zinc (“heavy duty”) batteries. They do not provide sufficient power for the pump to operate properly.
- Always have new batteries available for replacement. If power is lost, nondelivery of drug will occur.
- There is no pump alarm to alert users that the battery has not been properly installed or has become dislodged. An improperly installed or dislodged battery could result in loss of power and nondelivery of drug.
- If the pump is dropped or hit, the battery door may become broken or damaged. Do not use the pump if the battery door is damaged because the battery will not be properly secured; this may result in loss of power or nondelivery of drug.
- After clearing the program, the pump will not go into the run mode without programming a Continuous Rate or Demand Dose. The user may be required to program other cleared delivery parameters.
- Setting this New Patient Marker option clears any internal Lockout time and internal Delivery Limit. Once cleared, a Demand Dose could be requested and delivered immediately upon starting the pump, and the full volume could be delivered over the time period selected. You should reprogram all settings related to Dose Lockout, Max Doses per Hour and Delivery Limit, as appropriate for the particular patient.
- Attach the cassette properly. A detached or improperly attached cassette could result in unregulated gravity infusion of medication from the fluid container or a reflux of blood.
If you are using a Deltec administration set or medication cassette reservoir that does not have the flow stop feature (reorder number does not start with 21-73xx): you must use a CADD™ Extension Set with anti-siphon valve or a CADD™ Administration Set with either an integral or add-on anti-siphon valve to protect against unregulated gravity infusion that can result from an improperly attached cassette.
- When you enter a new Demand Dose Lockout time, any Demand Dose Lockout time in effect will be cleared. A Demand Dose could be requested and delivered immediately upon starting the pump, resulting in over-

delivery.

- When you enter a new Max Doses per Hour value, any lockout time in effect will be cleared. A Demand Dose could be requested and delivered immediately upon starting the pump, resulting in over-delivery.
- With the pump stopped and in LL0 ONLY: Entering a new Delivery Limit will reset the delivery limit feature. When Delivery Limit is reset, any delivery accumulated toward the Delivery Limit is automatically cleared. This will allow delivery to begin as soon as the pump is started, which may result in overdelivery.
- Per general rules of safe practice, always clamp tubing before removing the cassette from the pump. Removing the cassette without closing the clamp could potentially cause unregulated gravity infusion.
- Do not prime the fluid path with the tubing connected to a patient as this could result in overdelivery of medication or air embolism.
- Ensure that the entire fluid path is free of all air bubbles before connecting to the patient to prevent air embolism.
- Do not place the Remote Dose Cord where the button might accidentally be pushed. Accidentally pushing the button may deliver an inadvertent Demand Dose.
- Exercise care when using the Clinician Bolus function. Since there are no limits on the frequency of delivering a bolus, and since the amount of the bolus can be set as high as 20 ml (or the mg or mcg equivalent), you should not permit the patient to become familiar with the procedure for giving a Clinician Bolus.
- To prevent the patient from accessing the Clinician Bolus function, do not let the patient know the Clinician Bolus code.
- If Demand Doses are currently locked out, changing the Date and/or Time will cancel the lockout period. This will allow a Demand Dose to be requested and delivered as soon as you restart the pump, and may result in overdelivery.
- Changing the Date and/or Time will reset the Delivery Limit feature and clear any delivery accumulated towards the Delivery Limit. This will allow delivery to begin as soon as the pump is restarted, and may result in overdelivery.

CAUTIONS

- To avoid damaging the pump's electronics, do not operate the pump at temperatures below +2°C (36°F) or above 40°C (104°F).
- To avoid damaging the pump's electronics, do not store the pump at temperatures below -20°C (-4°F) or above 60°C (140°F). Do not store the pump with a Medication Cassette Reservoir or CADD™ Administration Set attached.
- To avoid damaging the pump's electronics, do not expose the pump to humidity levels below 10% or above 90% relative humidity.
- Do not store the pump for prolonged periods with the battery installed. Battery leakage could damage the pump.
- If you are using a Medication Cassette Reservoir in which the medication is frozen, thaw at room temperature only. Do not heat in a microwave oven as this may damage the product and cause leakage.
- Do not use the Remote Dose Cord to pick up or carry the pump. Using the cord in this manner could damage the pump or cord.
- To avoid damaging the connector or cord, do not use excessive force or instruments, such as pliers, to remove the Remote Dose Cord from the pump.
- Do not immerse the pump in cleaning fluid or water. Do not allow solution to soak into the pump, accumulate on the keypad, or enter the battery compartment, Data In/Out jack, Power jack or Air Detector port area. Moisture buildup inside the pump may damage the pump.
- Do not clean the pump with acetone, other plastic solvents, or abrasive cleaners, as damage to the pump may occur.
- Do not expose the pump to therapeutic levels of ionizing radiation as permanent damage to the pump's electronic circuitry may occur. The best procedure to follow is to remove the pump from the patient during therapeutic radiation sessions. If the pump must remain in the vicinity during a therapy session, it should be shielded, and its ability to function properly should be confirmed following treatment.
- Do not expose the pump directly to ultrasound, as permanent damage to the pump's electronic circuitry may occur.
- Do not use the pump in the vicinity of magnetic resonance imaging (MRI) equipment as magnetic fields may adversely affect the operation of the

pump. Remove the pump from the patient during MRI procedures and keep it at a safe distance from magnetic energy.

- Use of this pump on patients monitored by electronic equipment may cause artifactual interference. As with all electronic equipment, artifacts which affect the performance of other equipment, such as ECG monitors, can occur. The user should check the correct function of the equipment prior to use.
- To avoid damaging the pump's electronics, do not sterilize the pump.
- Use only Smiths Medical MD accessories as using other brands may adversely affect the operation of the pump.
- Check appropriate medication stability for time and temperature to assure stability with actual pump delivery conditions.

Table of Contents

WARNINGS	iii
CAUTIONS	vii
Section 1: General Description	1
1.1 Introduction	1
1.2 Indications	1
1.3 Epidural/Subarachnoid Administration	1
1.3.1 Analgesics	1
1.3.2 Anesthetics	1
1.4 Symbols	3
1.5 Pump Diagram	4
1.6 Description of the Keys, Display and Features	5
1.6.1 Indicator Lights	5
1.6.2 Display with backlighting	5
1.6.3 Keypad	5
1.6.4 Power jack	6
1.6.5 Data In/Out jack	6
1.6.6 Air Detector Port Cover	6
1.6.7 Air Detector accessory (optional)	6
1.6.8 Cassette	7
1.6.9 Polemount Bracket recess	7
1.6.10 Battery compartment	7
1.6.11 Cassette latch	7
1.6.12 Cassette / Keypad lock	8
1.6.13 Other Features Not Shown	8
1.7 The Main Screen	9
1.8 Lock Levels	10
1.8.1 AutoLock	10
1.8.2 Security Codes	10
1.8.3 Customizing the Security Codes	10
1.9 Lock Level Tables	11
Section 2: Pump Setup and Programming	13
2.1 Installing the Battery	13
2.1.1 To install a battery	14
2.2 Power Up	15
2.2.1 If Biomed Toolbox is set to clear records and lockouts in power up	15
2.2.2 If Biomed Toolbox is set to clear program in power up.....	16

General Description

Setup & Programming

Operating the Pump

Options

Biomed Toolbox

Reference & Troubleshooting

2.3	Unlocking the Pump Program to LL0	18
2.3.1	To unlock the pump program using the Cassette / Keypad Lock Key	18
2.3.2	To unlock the pump using the keypad	18
2.4	Programming the Pump: General Instructions	19
2.4.1	Messages you may see during programming	20
2.4.2	Before Beginning Programming	20
2.5	REPORTS Key	21
2.5.1	Dose Counters	21
2.5.2	Given	22
2.5.3	Doses Hour By Hour	22
2.5.4	Patient Review	23
2.5.5	Pain Scale	23
2.5.6	Pain Scale Log	24
2.5.7	Delivery Log	24
2.5.8	Event Log	25
2.5.9	New Patient Marker	25
2.5.9.1	If Biomed Toolbox is set to clear records and lockouts in Reports menu	25
2.5.9.2	If Biomed Toolbox is set to clear program in Reports menu	26
2.6	Delivery Methods	28
2.7	Programming Screens	29
2.7.1	Units (if applicable)	30
2.7.2	Concentration	30
2.7.3	Continuous Rate	30
2.7.4	Demand Dose	31
2.7.5	Demand Dose Lockout	31
2.7.6	Max Doses Per Hour	31
2.7.7	Set Delivery Limit	31
2.7.8	Reservoir Volume	32
2.7.9	Air Detector Status	32
2.8	Programming Example	33
2.9	Removing a Cassette	38
2.10	Attaching a Cassette	39
2.10.1	To attach the cassette to the pump	39
2.11	Priming the Tubing and Connecting to the Patient	42
2.12	Inserting the Tubing into the Air Detector	44
2.13	Locking the Pump Program for the Patient	45
2.13.1	To change the lock level when Autolock is not in use	45
2.14	Remote Dose Cord	47

2.14.1	To attach the Remote Dose Cord	47
2.14.2	To detach the Remote Dose Cord	47
2.15	Starting the Pump	48
2.16	Adjusting Patient Delivery (Titration)	49
2.16.1	Titration while the pump is running	49
Section 3:	Operating the Pump	51
3.1	Stopping the Pump	51
3.1.1	To stop the pump	51
3.1.2	To turn pump indicators off	51
3.2	Starting the Pump	51
3.2.1	To start the pump	52
3.2.2	To turn pump indicators off	52
3.3	Starting a Clinician Bolus	53
3.3.1	To start a Clinician Bolus	53
3.4	Starting a Demand Dose	55
3.4.1	To start a Demand Dose	55
3.5	Stopping a Demand Dose or Clinician Bolus	57
3.5.1	To stop a dose while the pump is running	57
3.6	Resetting the Reservoir Volume	58
3.6.1	Resetting Reservoir Volume without changing the cassette	58
Section 4:	Options	59
4.1	Overview: Accessing Options	59
4.1.1	To access Options	59
4.2	Lock Level	60
4.2.1	To change Lock Level	60
4.3	Epidural Mode	61
4.3.1	To turn Epidural Mode On or Off	62
4.4	Programming Units	62
4.4.1	To change Units	62
4.5	Time	63
4.5.1	To change the Time of Day	63
4.6	Date	64
4.6.1	To change the Date	64
4.7	Air Detector On/Off	65
4.7.1	To change the Air Detector Setting	66

Section 5: Biomed Toolbox	67
5.1 Overview: Accessing the Biomed Toolbox	67
5.1.1 To Access the Biomed Toolbox Menu	67
5.2 Custom Concentrations	68
5.3 Dosing Limits	69
5.4 Delivery Limit	70
5.5 Program Limits	70
5.6 Maximum Delivery Rate	71
5.7 Key Beeps	72
5.8 Res Vol Trip Point	72
5.9 Res Vol Empty Alarm	73
5.10 Pump Stopped Alarm	73
5.11 Titration Limit	74
5.12 AutoLock	75
5.13 PM (Preventive Maintenance) Reminder	76
5.14 Custom Lock Level Code	76
5.15 Custom Clinician Code	77
5.16 Units Selection	78
5.17 Units Location	78
5.18 Programming Units	79
5.19 Date Format	80
5.20 Custom Main Display	80
5.21 Auto Review	81
5.22 Custom Reports	81
5.22.1 To access the Custom Reports Screens	82
5.22.1.1 Dose Counters	82
5.22.1.2 Given	82
5.22.1.3 Doses Hour By Hour	82
5.22.1.4 Patient Review	82
5.22.1.5 Pain Scale	83
5.22.1.6 Pain Scale Log	83
5.22.1.7 Delivery Log	83
5.22.1.8 Event Log	83
5.22.1.9 New Patient Marker	84
5.23 New Patient Marker Function	84
5.23.1 To view or change the New Patient Marker Function	86
5.24 Upstream Sensor On/Off	87
5.25 Air Detector Requirement	88

Section 6: Reference & Troubleshooting	89
6.1 Troubleshooting	89
6.2 Alarms and Messages, Alphabetical List	90
6.3 Cleaning the Pump and Accessories	99
6.3.1 Cleaning the Battery Contacts	100
6.4 Exposure to Radiation or Magnetic Resonance Imaging (MRI) ...	101
6.5 Continuous Rate Scroll Ranges	102
6.6 Demand Dose, Clinician Bolus Scroll Ranges: Milliliters	102
6.7 Demand Dose, Clinician Bolus Scroll Ranges: Milligrams	103
6.8 Demand Dose, Clinician Bolus Scroll Ranges: Micrograms	104
6.9 Military Time Conversion Chart	105
6.10 Technical Description	106
6.10.1 Standards Used in Development of the Pump	106
6.10.2 Specifications (Nominal)	106
6.10.2.1 General Pump Specifications	106
6.10.2.2 Delivery Specifications	109
6.10.2.3 Options Specifications	110
6.10.2.4 Biomed Toolbox Specifications	110
6.10.3 Printed Reports	112
6.10.4 Screen Maps	113
6.11 Accuracy Test Results	115
6.12 Safety Features and Fault Detection	117
6.13 Data Handling and Software Safety Features	117
6.14 Inspection Procedures	120
6.15 Testing Procedures	121
6.16 Occlusion Pressure Range Tests	127
6.17 Accuracy Tests	130
Index	134
Limited Warranty	137

Section 1: General Description

1.1 Introduction

The Deltec CADD-Prizm® PCS II (Pain Control System) ambulatory drug delivery system provides measured drug therapy to patients in hospital or outpatient settings. Therapy should always be overseen by a physician or a certified, licensed healthcare professional. As appropriate, the patient should be instructed in using the pump.

1.2 Indications

The Deltec CADD-Prizm® PCS II pump is indicated for intravenous, intra-arterial, subcutaneous, intraperitoneal, epidural space, or subarachnoid space infusion. The pump is intended for therapies that require a continuous rate of infusion, patient-controlled demand doses, or both (such as patient-controlled analgesia).

1.3 Epidural/Subarachnoid Administration

The selected drug must be used in accordance with the indications included in the package insert accompanying the drug. Administration of any drug by this pump is limited by any warnings, precautions, or contraindications in the drug labeling.

1.3.1 Analgesics

Administration of analgesics to the epidural space is limited to use with indwelling catheters specifically indicated for either short- or long-term drug delivery.

Administration of analgesics to the subarachnoid space is limited to use with indwelling catheters specifically indicated for short-term drug delivery.

1.3.2 Anesthetics

Administration of anesthetics to the epidural space is limited to use with indwelling catheters specifically indicated for short-term drug delivery.

WARNING: Do not administer drugs to the epidural space or subarachnoid space unless the drug is indicated for administration to the those spaces. Drugs not intended for epidural or subarachnoid space infusion could result in serious







patient injury or death.

To prevent the infusion of drugs that are not indicated for epidural space or subarachnoid space infusion, DO NOT use administration sets that incorporate injection sites. The inadvertent use of injection sites for infusion of such drugs may cause serious patient injury or death.

If a Medication Cassette Reservoir, CADD™ Extension Set or CADD™ Administration Set is used for epidural space or subarachnoid space drug delivery, it is strongly recommended that it be clearly differentiated from those used for other routes of infusion, for example, by color coding, or other means of identification. Drugs not intended for epidural or subarachnoid space infusion could result in serious patient injury or death.



1.4 Symbols

	Alternating Current
	Accessory Jack
	Attention, consult accompanying documents (read Instructions for Use)
	Class II Equipment
	Type CF Equipment
IPX4	Splashproof - water splashed against pump housing will have no harmful effects (see Cleaning the Pump and Accessories, Section 6, for additional important information)
	Date of Manufacture
REF	Catalog (reorder) number
SN	Serial Number
Rx ONLY	CAUTION: Federal (USA) law restricts this device to sale by or on the order of a physician.
	Dispose of used batteries in an environmentally safe manner, and according to any regulations which may apply

1.5 Pump Diagram

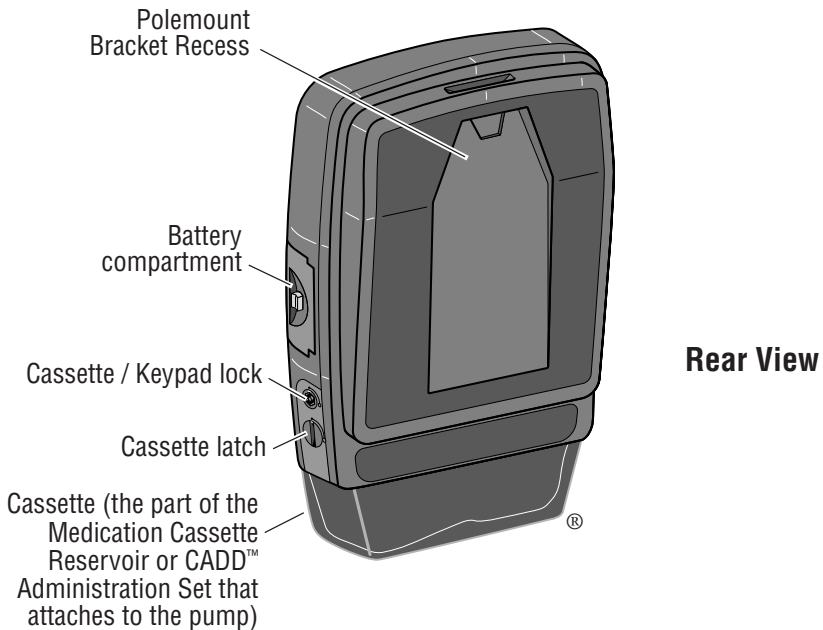
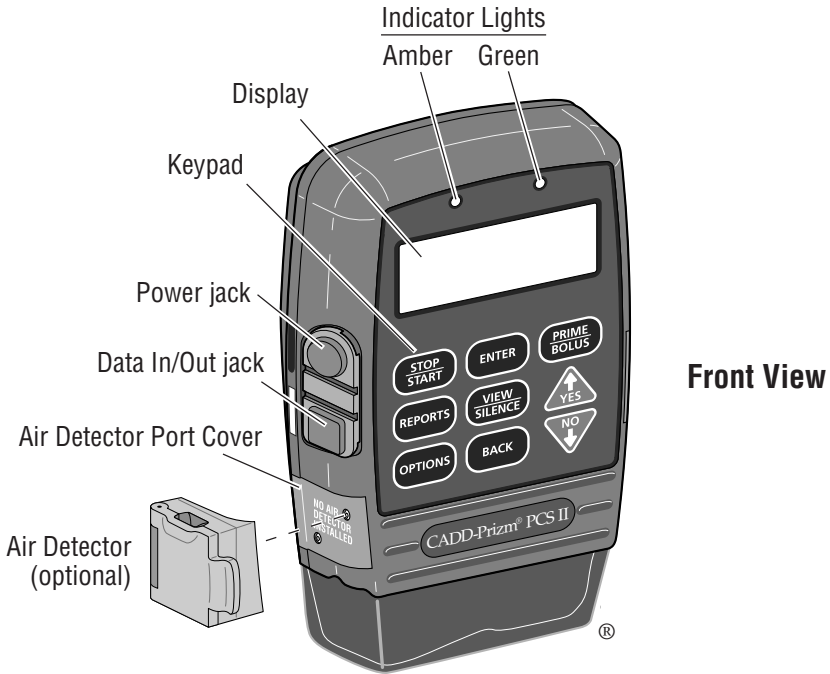

1.6 Description of the Keys, Display and Features

1.6.1 Indicator Lights

When the pump is being powered the indicator light flashes.

Green: The green light flashes to indicate that the pump is running and delivering fluid as programmed.

Amber: The amber light flashes when the pump is stopped or an alarm condition exists. It stays on continuously when the pump is inoperable. The display briefly describes the alarm condition.

If both lights are flashing, delivery is still occurring but an alert condition exists (for example, a low battery). Look at the display for a brief description of the alert condition.

1.6.2 Display with backlighting





The liquid crystal display (LCD) shows programming information and messages. Backlighting helps keep the display visible in low light. In this manual, “display” is synonymous with display panel or LCD.

After a period in which no keys are pressed, the backlighting turns off and the display blanks to save battery power (except during an alarm or when an external power source is in use). Press any key to turn the display back on.



NOTE: If you press , the display will reappear with a message asking if you wish to start or stop the pump; press  or .



1.6.3 Keypad

The keys on the keypad are described below. A key beeps when pressed if it is operable in the current lock level, provided Key Beeps have not been turned off in the Biomed Toolbox.

-  starts and stops pump delivery; silences alarms; used to access the pump’s Indicators Off feature (see Section 3, Operating the Pump).
-  is used to view the pump’s Reports. Press the key to enter the Reports screens, and press again to scroll through various reports screens.
-  is used to access the Options Menu, which contains such features as Lock Levels, Epidural Mode, Time and Date. (See Section 4, Options.)
-  is used to enter, or save, a new value in the pump’s memory when programming new doses or new pump settings. It is also used to select an item from the Options Menu (Section 4) or Biomed Toolbox Menu (Section 5).

 is used to view the programming screens without changing the setting or value displayed. It is also used to return from the Options Menu to the main screen, from the Reports menu to the main screen, or from the Biomed Toolbox Menu to the Options Menu. (See the appropriate sections of this manual.) It is also used to silence pump alarms.

 allows the user to back up to the previous screen in programming, Reports or Options.  is not operable in the Biomed Toolbox.

 has two functions. When the pump is stopped, pressing  accesses the priming feature. When the pump is running, pressing  accesses the Clinician Bolus feature. For more information on these features, see the appropriate section of this manual.

 allows you to answer “yes” to a question on the pump’s display, “scroll up” or increase a value (for example, a dose amount), or scroll through items on a menu.

 allows you to answer “no” to a question on the pump’s display, “scroll down” or decrease a value, scroll through items on a menu, or cancel printing.

1.6.4 Power jack

You may plug a CADD™ External Power Source (EPS) system power pack or an AC Adapter into the Power jack as an alternate source of power.

1.6.5 Data In/Out jack

The Data In/Out jack is used for attaching the following accessories:

- **Interface Cable** for printing reports
- **Remote Dose Cord**
- **Interface Cable/Null Modem Cable** for communications

For more information on the Remote Dose Cord, see the appropriate section in this manual. For more information on printing or communications, see the instructions for use provided with the interface cable.

1.6.6 Air Detector Port Cover

This encloses the Air Detector port when the Air Detector is not attached.

1.6.7 Air Detector accessory (optional)

The Air Detector attaches to the pump in the area shown in the diagram. If air is detected in the part of the tubing that passes through the Air Detector, an alarm

sounds and delivery stops. (See Section 6 for Air Detector specifications.) The pump may be customized to require an Air Detector (see Section 5, Biomed Toolbox). If an Air Detector is attached but not required, it may be turned off (see Section 4, Options).

WARNING: When the Air Detector is not installed, or is installed but turned off, the pump will not detect air in the fluid path. It is recommended that you periodically inspect the fluid path and remove any air to prevent air embolism. Air embolism could result in serious patient injury or death.

1.6.8 Cassette

The cassette is the part of the Medication Cassette Reservoir or CADD™ Administration Set that attaches to the bottom of the pump. The following single-use products are compatible with the pump:

- Medication Cassette Reservoir (50 or 100 ml), used with a CADD™ Extension Set
- CADD™ Administration Set

WARNING: Follow the Instructions for Use provided with the Medication Cassette Reservoir and CADD™ Extension Set, or the CADD™ Administration Set, paying particular attention to all warnings and cautions associated with their use. Incorrect preparation and/or use of these products could result in serious patient injury or death.

1.6.9 Polemount Bracket recess

The optional Polemount Bracket slides into the recess on the back of the pump, allowing you to attach the pump to an IV pole.

1.6.10 Battery compartment

The 9 volt battery fits into this compartment. The 9 volt battery serves as the primary source of power, or as a backup when an EPS System power pack or AC Adapter is in use.

1.6.11 Cassette latch

This attaches the cassette to the pump. The pump detects whether the cassette is latched properly. Delivery will stop and an alarm will occur if the cassette becomes unlatched.

1.6.12 Cassette / Keypad lock

This allows you to secure the cassette to the pump using the key provided. The cassette must be latched before it can be locked. The Cassette/keypad lock also works together with the AutoLock feature to lock or unlock the pump program (see Lock Levels, this section, for more information).



1.6.13 Other Features Not Shown



Downstream Occlusion Sensor: The pump contains a downstream occlusion sensor. When a downstream occlusion between the pump and patient access site is detected, an alarm will sound, delivery will stop, and the display will show “High Pressure.”

Upstream Occlusion Sensor: The pump contains an upstream occlusion sensor. This feature may be turned on or off (see Section 5, Biomed Toolbox). When the sensor is turned on, and an upstream occlusion (between pump and fluid container) is detected, an alarm will sound, delivery will stop, and the display will show “Upstream Occlusion.”

WARNING: When the Upstream Occlusion Sensor is turned Off, the pump will not detect occlusions upstream (between pump and fluid container). It is recommended that you periodically inspect the fluid path for kinks, a closed clamp, or other upstream obstructions. Upstream occlusions may result in under- or nondelivery of medications. If undetected, these occlusions could lead to serious patient injury or death.

Reservoir Volume Alarm: Reservoir Volume is a feature that indicates when the fluid in the fluid container is low or depleted. Each time you change the fluid container, you may reset the Reservoir Volume to the originally programmed volume. Then, as medication is delivered, the Reservoir Volume automatically decreases. When the pump calculates that 5 ml remain in the fluid container, beeps sound and “Reservoir Volume Low” appears. This alarm recurs at every subsequent decrease of 1 ml until the Reservoir Volume reaches 0 ml, at which point the pump stops.

As an option, the Reservoir Volume Alarm can be replaced with the Reservoir Volume Trip Point in the Biomed Toolbox. This alert sounds when the pump calculates that a user programmable amount remains in the fluid container, and can be silenced by pressing  or .

NOTE: If you press , the display will reappear with a message asking if you wish to start or stop the pump; press  or .



1.7 The Main Screen

The main screen is the starting point for programming or viewing the pump's settings. The main screen may be customized in the Biomed Toolbox (see Custom Main Screen, Section 5). The following information may be displayed:

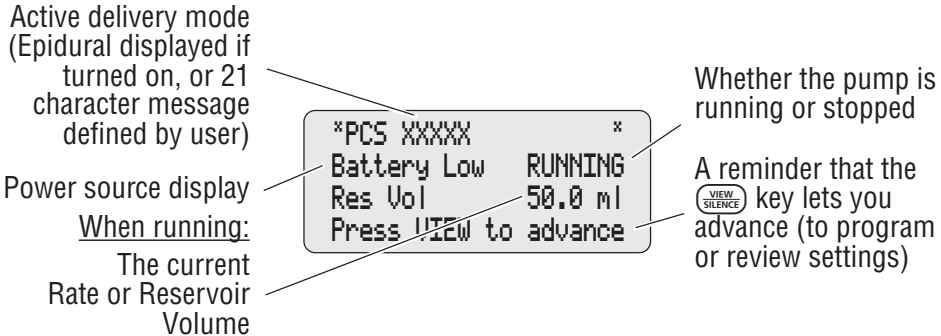

If no keys are pressed for 2 minutes when the pump is stopped, or 1 minute when running, the display reverts to the main screen. When the 9 volt battery is low, "Battery Low" appears on the main screen.

1.8 Lock Levels

Lock levels are used to limit patient access to certain programming and operating functions. The table on the next page lists the functions that are accessible in LL0 (Lock Level 0 - pump program and keypad completely unlocked), LL1 (Lock Level 1 - limited access to pump program and keypad), and LL2 (Lock Level 2 - minimal access to pump program, keypad is locked). When a function is accessible, the key associated with the function beeps when pressed (unless key beeps are disabled in the Biomed Toolbox). If a function is not accessible, the pump ignores the key press and a beep does not sound. Setting the locks levels are described in Section 4, Options.

1.8.1 AutoLock

The AutoLock feature automatically changes the lock level from LL0 to LL1 or LL2 when the pump is started. See Section 5 for more information on using AutoLock.

1.8.2 Security Codes

The following security codes are preset by the manufacturer for the clinician's use:

**** Text omitted from online version ****

WARNING: Do not disclose to the patient the pump's security codes or any other information that would allow the patient complete access to all programming and operating functions. Improper programming could result in serious patient injury or death.

1.8.3 Customizing the Security Codes

If it becomes necessary to change the Lock Level Code, Clinician Bolus Code and/or Biomed Toolbox Code to ensure that a patient will be unable to access these features, you may customize the codes in the Biomed Toolbox. Customizing the Clinician Bolus Code will not affect the Lock Level Code, although the codes may be the same (see Section 5.)

1.9 Lock Level Tables

These tables list the operations that are accessible in each lock level while the pump is stopped and running. LL0 permits complete access to all programming and operating functions. LL1 permits limited access to pump programming and operations. LL2 permits only minimal access to the pump.

Pump Operations and Programming	Stopped			Running		
	LL0	LL1	LL2	LL0	LL1	LL2
Stop/Start the pump	Yes	Yes	Yes	Yes	Yes	Yes
Prime	Yes	Yes	No	No	No	No
Reset Reservoir Volume	Yes	Yes	Yes	No	No	No
Change the lock level	Yes*	Yes*	Yes*	Yes*	Yes*	Yes*
Start a Demand Dose	No	No	No	Yes	Yes	Yes
Start a Clinician Bolus	No	No	No	Yes, w/code	Yes w/code	Yes w/code
Change Units	Yes	No	No	No	No	No
Change Concentration	Yes	No	No	No	No	No
Change Continuous Rate	Yes	Up to titration limit	No	Up to titration limit	Up to titration limit	No
Change Demand Dose	Yes	Up to titration limit	No	Up to titration limit	Up to titration limit	No
Change Max Doses per Hour	Yes	No	No	No	No	No
Change Demand Dose Lockout	Yes	No	No	No	No	No
Change Delivery Limit	Yes	Up to titration limit	No	Up to titration limit	Up to titration limit	No
Print/Communications	Yes	Yes	Yes	Yes	Yes	Yes

*With code or cassette / keypad lock key

Section 1: General Description

Pump Options	Stopped			Running		
	LL0	LL1	LL2	LL0	LL1	LL2
Biomed Toolbox	Yes, w/code	No	No	No	No	No
Lock Level	Yes*	Yes*	Yes*	Yes*	Yes*	Yes*
Epidural Mode	Yes	View only	View only	No	No	No
Units	Yes	View only	View only	No	No	No
Time	Yes	View only	View only	No	No	No
Date	Yes	View only	View only	No	No	No
Air Detector	Yes	View only	View only	No	No	No
Report Options	Stopped			Running		
	LL0	LL1	LL2	LL0	LL1	LL2
Dose Counters (clear or view)	Yes	Yes	Yes	Yes	Yes	Yes
Given (clear or view)	Yes	Yes	Yes	Yes	Yes	Yes
Doses Hour by Hour (view)	Yes	Yes	Yes	Yes	Yes	Yes
Patient Review (view)	Yes	Yes	Yes	Yes	Yes	Yes
Pain Scale	Yes	Yes	Yes	Yes	Yes	Yes
Pain Scale Log (view)	Yes	Yes	Yes	Yes	Yes	Yes
Delivery Log (view)	Yes	Yes	Yes	Yes	Yes	Yes
Event Log (view)	Yes	Yes	Yes	Yes	Yes	Yes
New Patient Marker	Yes	No	No	No	No	No

*With code or cassette / keypad lock key

Section 2: Pump Setup and Programming

2.1 Installing the Battery

Use a new, 9 volt alkaline or lithium battery such as the DURACELL® Alkaline MN 1604, the EVEREADY® ENERGIZER® Alkaline #522 or the ULTRA-LIFE® Lithium U9VL battery. The pump retains all programmed values while the battery is removed. If the pump is running, you may connect an external power source to keep the pump running for 3 minutes while you change the battery.

Dispose of used batteries in an environmentally safe manner, and according to any regulations which may apply.

NOTE: Once the battery is inserted, you must then check the Time and Date and program as appropriate (see the Options section of this manual).

WARNING:

- Do not use rechargeable NiCad or nickel metal hydride (NiMH) batteries. Do not use carbon zinc (“heavy duty”) batteries. They do not provide sufficient power for the pump to operate properly, which could result in death or serious injury to the patient.
 - Always have new batteries available for replacement. If power is lost, nondelivery of drug will occur and, depending on the type of drug being administered, could result in death or serious injury to the patient.
 - There is no pump alarm to alert users that a battery has not been properly installed or has become dislodged. An improperly installed or dislodged battery could result in loss of power and nondelivery of drug and, depending on the type of drug being administered, could result in death or serious injury to the patient.
 - If the pump is dropped or hit, the battery door may become broken or damaged. Do not use the pump if the battery door is damaged because the battery will not be properly secured; this may result in loss of power, nondelivery of drug, and, depending on the type of drug being administered, death or serious injury to the patient.
-
-

2.1.1 To install a battery

1. Make sure the pump is stopped. Press the button on the battery door and slide the battery door forward. Remove the used battery.

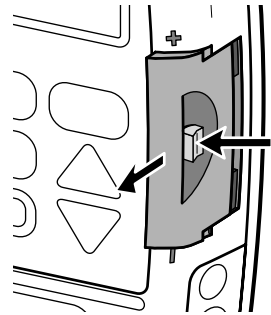

2. Match the + and – markings on the new battery with the markings on the pump. Insert the battery. The pump will beep if the battery is inserted correctly.
3. Replace the battery door. The pump will begin to power up.

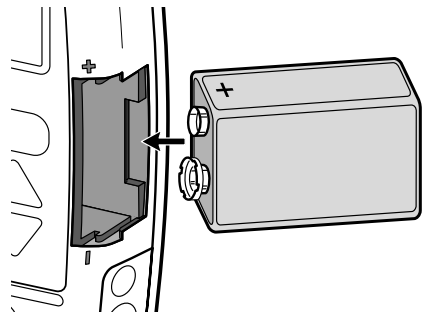

NOTE: If you put the battery in backwards, the display will remain blank. Reinsert the battery, making sure to match the + and – markings.

CAUTION: Do not store the pump for prolonged periods with the battery installed. Battery leakage could damage the pump.

NOTES:



- Battery life is dependent on the amount of medication delivered, delivery rate, battery age, temperature, frequent screen display and backlighting and frequent printing.
- The power of the battery will be quickly depleted at temperatures below +10°C (50°F).

2.2 Power Up

When you install a battery or turn the pump indicators on by pressing any key on the keypad, the pump will start its power up sequence during which it performs self-tests, may display programmed values and, if turned on in the Biomed Toolbox, allows you to program a New Patient Marker. Watch for the following:



- Pump model number, last error code (“lec”) if any, and serial number (“sn”) will appear.
- The delivery mode contained in the pump and its software version will appear.
- The display will turn completely on. Look for any stripes, which would indicate a faulty display.
- The pump will briefly pause. Then a message will appear showing the delivery mode that is currently active.
- If no Air Detector is attached, “No Air Detector attached” will appear. The Automatic Review will appear if turned on in the Biomed Toolbox. If messages appear, see the Alarms and Messages Table in Section 6 of this manual for further explanation and instruction.
- If turned on in the Biomed Toolbox, the new patient marker screens will appear.

2.2.1 If Biomed Toolbox is set to clear records and lockouts in power up (Power Up No Clear)

1. If this is a new patient, press  (if this is not a new patient, press ).

Is this a new patient?

Press YES or NO

2. If you want to program a new patient marker and clear the previous records and lockouts, press  (if you press , the pump will continue with its power up routine and advance to the main screen).

Insert New Patient Marker, clear reports & lockouts?
Press YES or NO

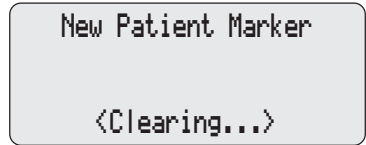

3. Pressing  will cause the following to occur:

- An event is added to the Event Log.
 - The Pain Scale Log, Delivery Log, Doses Hour by Hour, and Patient Review Log are cleared.
 - Given is cleared.
 - Doses Attempted and Doses Given are cleared.
 - Dose Lockout time is cleared.
 - Any internal Delivery Limit data is cleared.
3. A screen appears to let you know the new patient marker is being entered.





WARNING: Setting this New Patient Marker option clears any internal Lockout time and internal Delivery Limit. Once cleared, a Demand Dose could be requested and delivered immediately upon starting the pump, and the full volume could be delivered over the time period selected. You should reprogram all settings related to Dose Lockout, Max Doses per Hour and Delivery Limit, as appropriate for the particular patient. Failure to program these settings could result in overdelivery, causing death or serious injury to the patient.

2.2.2 If Biomed Toolbox is set to clear the program, records and lockouts in power up (Power Up Clear)

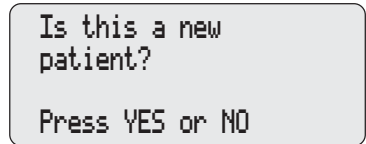
1. If this is a new patient, press  (if this is not a new patient, press .



2. If you want to program a new patient marker and clear the program, press  (if you press , the pump will continue with its power up routine and advance to the main screen).

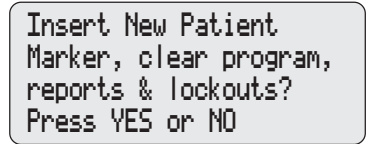

Pressing  will cause the following to occur:



- An event is added to the Event Log.

- Records and lockouts are cleared, as described in 2.2.1, above.
- Concentration (if units are milligrams or micrograms) defaults to the highest value (100 mg/ml or 500 mcg/ml, or highest value not customized to “Off” in Custom Concentrations in Biomed Toolbox), and must be confirmed.
- The user may be required to program Units, Concentration, Rate, Dose and Delivery Limit, depending on the pump program parameters that are in use, and the following program values are defaulted:
 - Continuous Rate defaults to 0, and must be confirmed.
 - Demand Dose defaults to 0, and must be confirmed.
 - Demand Dose Lockout defaults to “24 Hrs 00 Min.”
 - Max Doses per Hour defaults to 1.
 - Delivery Limit defaults to lowest programmable value.
 - Reservoir Volume defaults reset to previously programmed value.
 - Lock Level changes to LL0.

WARNING: After clearing the program, the pump will not go into the run mode without programming a Continuous Rate or Demand Dose. The user may be required to program other cleared delivery parameters. If any of the other changed parameters are not reprogrammed, under delivery can result which, depending on the medication being delivered, may cause death or serious injury to the patient.

- When power up is complete, “Power Up Successful” will appear, six beeps will sound, and the pump will be stopped.

NOTES:

- When the pump is powered up in Lock Level 0 with an Air Detector attached, the pump will automatically turn on the Air Detector (the Air Detector setting in Options will change to “Turned On”).
- To move quickly through the power-up screens, press  repeatedly. To skip the automatic review entirely, press . The Automatic Review will not appear at power-up if it was turned off in the Biomed Toolbox.

2.3 Unlocking the Pump Program to LL0

Before programming the pump, make sure the lock level is LL0. LL0 allows the clinician to access all programming and operating functions.

If you power up the pump (insert a battery or turn the indicators on) *without a cassette attached*, the pump will automatically unlock the program to LL0.

2.3.1 To unlock the pump program using the Cassette / Keypad Lock Key

In order to use this function, the AutoLock setting in the Biomed Toolbox (Section 5) must be set to “LL1 Key/Code” or “LL2 Key/Code.”

1. To unlock the pump program to LL0 (pump program and keypad completely unlocked), the pump must be stopped.
2. Insert the key into the cassette / keypad lock and unlock the cassette. The lock Level will automatically unlock to LL0.

NOTE: To unlock the pump to LL1 (limited access to pump program and keypad), the pump must be running.

```
*PCS XXXXX *
Battery Low STOPPED
Res Vol 50.0 ml
Press VIEW to advance
```

```
Cassette Unlocked

<Unlocking keypad...>
```

WARNING: Attach the cassette properly. A detached or improperly attached cassette could result in unregulated gravity infusion of medication from the fluid container or a reflux of blood, which could result in death or injury to the patient.

If you are using a Deltec administration set or medication cassette reservoir that does not have the flow stop feature (reorder number does not start with 21-73xx): you must use a CADD™ Extension Set with anti-siphon valve or a CADD™ Administration Set with either an integral or add-on anti-siphon valve to protect against unregulated gravity infusion that can result from an improperly attached cassette. Unregulated gravity infusion can result in death or serious injury.

2.3.2 To unlock the pump program using the keypad

1. To unlock the pump program to LL0, the pump must be stopped. Press **OPTIONS** for Lock Level function.

```
Options Menu
⇄ Lock Level

Press ▲ or ▼ or ENTER
```

2. Press **ENTER**.

```
Lock Level Code
000

To Unlock Keypad
Enter Code
```

NOTE: If <Enter Custom Code> appears on the screen, the Lock Level Code has been customized. Enter the custom Lock Level Code in the next step.

3. Press  or  until the Lock Level Code **** Text Omitted **** appears.



4. Press  to unlock the pump program. Watch the display to verify that the pump program is unlocking. If you do not see this message, the lock level has not changed. Repeat the above steps.

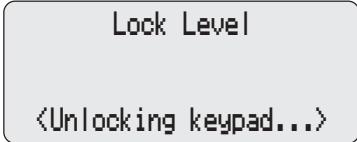

WARNING: Do not disclose to the patient the pump's security codes or any other information that would allow the patient complete access to all programming and operating functions. Improper programming of the pump could result in death or serious injury to the patient.

NOTE: If the pump is running when you attempt to unlock the pump program, not all of the above steps will be required.

2.4 Programming the Pump: General Instructions

WARNING: Ensure that the $\pm 6\%$ System Delivery Accuracy specification is taken into account when programming the pump and/or filling the Medication Cassette Reservoir. Failure to do so may result in medication in the reservoir becoming depleted sooner than expected. If the pump is being used to deliver critical or life sustaining medication, the interruption in the delivery of medication could result in patient injury or death.

The  symbol means you may use the  or  key to change the setting



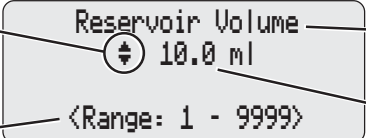

"Range" shows the minimum and maximum settings



Screen name

Setting

The procedure for changing a programmed setting is similar for most programming screens. The following example of the Reservoir Volume screen illustrates the typical features of a programming screen:

- Make sure the pump is stopped and in Lock Level 0 (pump program and keypad completely unlocked).
- To begin programming, start at the main screen and press .
- To change a setting, press  or  until the desired setting appears. (Press and hold these keys to change values with increasing speed.) Then press  to save the new setting. The next screen will appear automatically.
- To leave a setting unchanged, press  to go to the next screen.

2.4.1 Messages you may see during programming



During programming, the following messages may appear:

“Press ENTER to save” will appear 10 seconds after you change a setting to remind you to press .

“Entering...” “Changing...” or “Resetting...” means the new setting is being entered into the pump’s memory. The pump will display this message, then automatically go to the next screen.

“Change — to...?” may appear for the following reasons:

- you entered a new setting that must be confirmed,
- entry is required because you changed Units or Concentration, or
- you changed a setting and pressed a key other than .

Press  to confirm the setting. If you do not press  within 20 seconds, or if you press , the screen will revert to the previous setting.

2.4.2 Before Beginning Programming

There are certain settings in Options and Biomed Toolbox which need to be set before beginning any programming, as turning certain of these settings on and off may clear other programming functions.

2.5 REPORTS Key

The  key is used to access a variety of reporting and record-keeping functions. The reports menu can be customized in the Biomed Toolbox by enabling (or turning on) only those reports that you are interested in. Access to reports is dependent on the pump's Lock Level (see Lock Level Tables at the end of Section 1).

To scroll through the available reports, press  or . You can exit the reports screens at any time by pressing .

NOTE: Only those reports which have been enabled (or turned on) in the Biomed Toolbox (see Section 5, this manual) will be displayed when you press . The following information assumes that each of the Reports is enabled in the Biomed Toolbox.

2.5.1 Dose Counters

This screen appears if it is turned on in the Biomed Toolbox and you have programmed a Demand Dose. It shows the number of Demand Doses given and attempted since the date and time indicated, which is the last time they were cleared manually, or by adding a New Patient Marker. (If the counters reach 999, they automatically return to zero and continue counting.) Even if these counters show zeros, you should clear them before beginning programming to update the time and date markers.

- **Given** shows the number of Demand Doses actually delivered to the patient, including any doses stopped in progress.
- **Attempt** shows the total number of Demand Doses attempted by the patient while the pump was running, including those that were delivered, locked out, and stopped in progress.

The Dose Counters can be viewed or cleared while the pump is running or stopped, in any Lock Level.

To clear the Dose Counters:

1. Press  until the Dose Counters screen appears.

```
Dose Counters
Given/Attempt: 4/ 5
since 01/01/00 07:14
Press ENTER to clear
```

2. Press  to clear the dose counters.

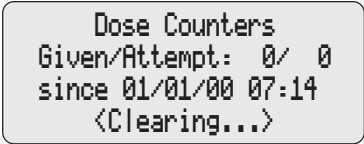



2.5.2 Given

This screen appears if it has been turned on in the Biomed Toolbox, and shows the total amount of fluid delivered since the time and date indicated, which is the last time the value was cleared manually, or by adding a New Patient Marker. The amount shown is rounded to the nearest 0.01 mg, ml or mcg. (If this value reaches 99999.99, it automatically returns to zero and continues counting.) The Given amount does not include drug delivered during priming. Even if this screen shows zero, you should clear it before beginning programming to update the time and date markers.

Given may be viewed or cleared with the pump running or stopped, in any Lock Level.

To view or clear Given:

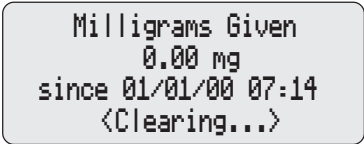
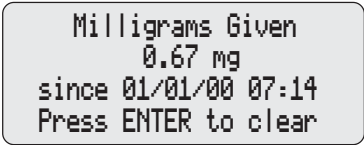

1. Press  until the Given screen appears.
2. Press  to clear Given.



2.5.3 Doses Hour By Hour

This screen appears if it was turned on in the Biomed Toolbox, and shows the number of doses delivered and attempted for each hourly period over the last 48 hours (or since a New Patient Marker was added, if less). Doses Hour By Hour is maintained by the pump, and is only cleared when a New Patient Marker is added.

To view Doses Hour by Hour:

1. Press  until the Doses Hour By Hour screen appears.
2. Press  or  to scroll through each hourly values.

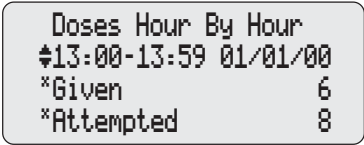

2.5.4 Patient Review

This screen appears if it has been turned on in the Biomed Toolbox, and allows you to review a summary of the pump's current settings, and the number of doses given and attempted, beginning at a date and time (no longer than 48 hours) that you program. Patient Review is maintained by the pump, and may be viewed at any time in any Lock Level, with the pump running or stopped. Patient Review is automatically cleared when a New Patient Marker is added.

To View Patient Review:

1. Press **REPORTS** until the Patient Review screen appears.
2. Press **YES** or **NO** to select the start time and date. All start times begin on the hour. Press **ENTER**.
3. The first screen, "Pump Settings 1" appears. Press **YES** to page forward or **NO** to page backward.

```
Patient Review Start
  ⚡ 12:00 01/01/00
Press ▲ or ▼ or ENTER
```

```
Patient Review
  ⚡ Pump Settings 1
Res Vol      1.0 ml
```

2.5.5 Pain Scale

The Pain Scale appears if it has been turned on in the Biomed Toolbox, and allows you and/or the patient to enter a pain scale rating. The pain scale has a range of 0 (no pain) to 10 (severe pain). The screen includes a horizontal bar chart representing the selected pain value. When a pain value is entered, a time and date stamp is added to the Pain Scale Log, and is included in the Delivery Log and Event Log. Pain Scale entries may be accomplished at any time, with the pump running or stopped, in any Lock Level.

To Program Pain Scale:

1. Press **REPORTS** until the Pain Scale appears.
2. Press **YES** or **NO** to raise or lower the Pain Scale rating, then press **ENTER**.



```
Pain Scale
None  ⚡  5  Severe
████████████████████
<Range: 0 - 10>
```

```
Pain Scale
      2
<Entering...>
```

2.5.6 Pain Scale Log

The Pain Scale Log appears if it has been turned on in the Biomed Toolbox, and displays all Pain Scale entries since the last time a New Patient Marker was added. The Pain Scale value, along with the time and date of the entry, are included in the display. It may be viewed at any time, with the pump running or stopped, in any Lock Level.

To View the Pain Scale Log:

1. Press  until the Pain Scale Log screen appears. Press  or  to scroll through the Pain Scale Log entries.

```
Pain Scale Log Entry
# 01/01/00 at 14:04
Pain Scale entered 5
```



2.5.7 Delivery Log

The Delivery Log appears if it has been turned on in the Biomed Toolbox, and is a subset of the Event Log, and includes information having to do specifically with delivery events. Delivery Log information includes:

- Patient Dose Information (delivered, and denied either because of Dose Lockout or Delivery Limit being reached).
- Clinician Boluses.
- Pain Scale entries.
- Changes to delivery parameters (including Continuous Rate, Demand Dose, Demand Dose Lockout, Delivery Limit).
- Manually stopping a Demand Dose and/or Clinician Bolus.
- Pump started, stopped, powered up and powered down.

The Delivery Log is maintained by the pump, and displays all entries since the last time a New Patient Marker was added. The Delivery Log can be viewed at any time, with the pump running or stopped, in any Lock Level.

To View the Delivery Log:

1. Press  until the Delivery Log appears. Press  or  to scroll through the Delivery Log entries.



```
Delivery Log Entry
# 01/01/00 at 14:04
Pain Scale entered 5
```

2.5.8 Event Log

The Event Log appears if it has been turned on in the Biomed Toolbox, and records the following types of events: hourly given totals, dose delivery, alarms, errors, power source changes, cassette changes and changes to pump programming or settings. The pump records the time and date of each event, and lists events in order starting from the most recent through the last 500 events.

The pump may be running or stopped, and in any Lock Level.

To view the Event Log:

1. Press  until the Event Log screen appears. Press  or  to scroll through the Event Log entries.



```
Event Log Entry
♦ 01/01/00 at 14:04
Pain Scale entered 5
```

2.5.9 New Patient Marker

The New Patient Marker appears if it has been turned on in the Biomed Toolbox (see Section 5.15.1.9). New Patient Marker only appears in the Reports menu when the pump is stopped and in LL0. When a New Patient Marker is selected, and depending on the program setting of the New Patient Marker feature in the Biomed Toolbox (see Section 5.16), one of the following will occur:



- Patient records and lockouts are cleared.
- The program, patient records and lockouts are cleared.

2.5.9.1 If Biomed Toolbox is set to clear records and lockouts in the Reports menu

1. If this is a new patient, press  (if this is not a new patient, press ).

```
Is this a new
patient?
```

```
Press YES or NO
```

2. If you want to program a new patient marker and clear the previous records and lockouts, press  (if you press , the pump will return to the Reports menu).

```
Insert New Patient
Marker, clear
reports & lockouts?
Press YES or NO
```

Pressing  will cause the following to occur:

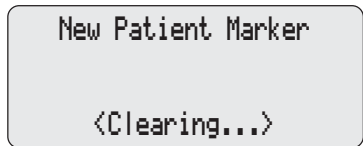

- An event is added to the Event Log.
- The Pain Scale Log, Delivery Log, Doses Hour by Hour, and Patient Review Log are cleared.
- Given is cleared.
- Doses Attempted and Doses Given are cleared.
- Dose Lockout time is cleared.
- Any internal Delivery Limit data is cleared.

3. A screen appears to let you know the new patient marker is being entered.





WARNING: Setting this New Patient Marker option clears any internal Lockout time and internal Delivery Limit. Once cleared, a Demand Dose could be requested and delivered immediately upon starting the pump, and the full volume could be delivered over the time period selected. You should reprogram all settings related to Dose Lockout, Max Doses per Hour and Delivery limit, as appropriate for the particular patient. Failure to program these settings could result in overdelivery, causing death or serious injury to the patient.

2.5.9.2 If Biomed Toolbox is set to clear the program, records and lockouts in the Reports menu

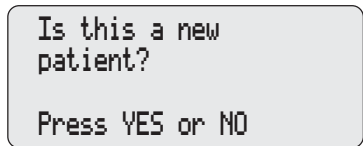
1. If this is a new patient, press  (if this is not a new patient, press ).



2. If you want to program a new patient marker and clear the program, press  (if you press , the pump will return to the Reports menu).

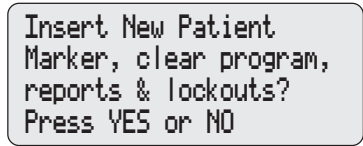

Pressing  will cause the following to occur:

- An event is added to the Event Log.



- Records and lockouts are cleared, as described in 2.5.9.1, above.
- Concentration (if units milligrams or micrograms) defaults to the highest value (100 mg/ml or 500 mcg/ml, or highest value not customized to off in Custom Concentrations in Biomed Toolbox), and must be confirmed.
- The user may be required to program Units, Concentration, Rate, Dose and Delivery Limit, depending on the pump program parameters that are in use, and the following program values are defaulted:
 - Continuous Rate defaults to 0, and must be confirmed.
 - Demand Dose defaults to 0, and must be confirmed.
 - Demand Dose Lockout defaults to “24 Hrs 00 Min.”
 - Max Doses per Hour defaults to 1.
 - Delivery Limit defaults to lowest programmable value.
 - Reservoir Volume defaults reset to previously programmed value.
 - Lock Level changes to LL0.

WARNING: After clearing the program, the pump will not go into the run mode without programming a Continuous Rate or Demand Dose. The user may be required to program other cleared delivery parameters. If any of the other changed parameters are not reprogrammed, under delivery can result which, depending on the medication being delivered, may cause death or serious injury to the patient.

2.6 Delivery Methods

The pump provides the following methods of delivery:

- **Continuous Rate**
- **Demand Dose**, activated by the patient
- **Clinician Bolus**, activated by the clinician.

You may program each of the methods individually or in combination. The following graph illustrates the combined delivery methods. The Continuous Rate and Demand Dose are programmed as described in this section. The Clinician Bolus feature is described in Section 3, Operating the Pump. Ranges and programming increments are listed in the Specifications in Section 6.

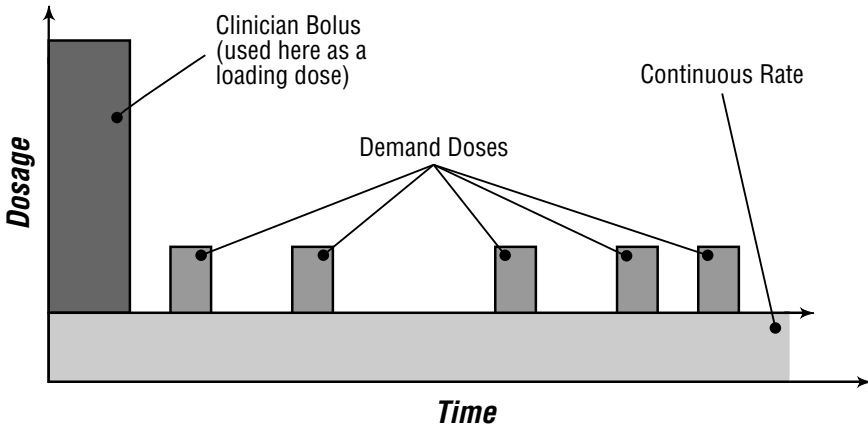

2.7 Programming Screens

These are the programming screens. Descriptions of the screens follow. If Units programming is set as part of Options menu or as part of Biomed Toolbox (see Biomed Toolbox, Section 5), you may want to view and/or change Units (milliliters, milligrams or micrograms), in the Option menu or Biomed Toolbox (see Section 4, Options or Section 5, Biomed Toolbox) before beginning programming.

Units (ml, mg or mcg)
(if set as part of programming screens -
see Section 5, Biomed Toolbox)

Units
⬆ Milligrams
<Range: mg, ml, mcg>

Concentration
(mg/ml or mcg/ml)

Concentration
⬆ 100.0 mg/ml
<Range: 0.1 - 100>

Continuous Rate

Continuous Rate
⬆ 0.00 mg/hr
<Range: 0 - 3000.00>

Demand Dose

Demand Dose
⬆ 0.05 mg
<Range: 0 - 990.0>

Demand Dose Lockout

Demand Dose Lockout
⬆ 05 min
<Range: 1 min-24 hrs>

Max Doses Per Hour

Max Doses Per Hour
⬆ 3
<Range: 1 - 12>

Set Delivery Limit	Set 1 hour limit ⚡ 1.00 mg <Range: 1-100000 mg>
Reservoir Volume	Reservoir Volume ⚡ 10.0 ml <Range: 1 - 9999>
Air Detector (review)	Air Detector Required <Review Only>

2.7.1 Units (if applicable)

The Biomed Toolbox allows you to program the display so that Units appears as part of the Options menu, the Biomed Toolbox menu or here as part of the programming screens. Enter the programming units. Possible settings are milliliters (ml), milligrams (mg), and micrograms (mcg). When you change the Units, the pump requires you to enter or verify the Continuous Rate, Demand Dose and Delivery Limit. If Units are mg or mcg, you must also enter Concentration.

NOTE: The units screen will not appear if only one unit type has been programmed in the “Units Selection” feature in the Biomed Toolbox, or Units Location has been programmed to the Options Menu or Biomed Toolbox. The range in the Units screen will display “Custom” if two units have been selected in the Units Selection feature. The scroll range on the Units screen will include only the selected units.

2.7.2 Concentration

If Units are mg or mcg, enter the concentration of drug in mg/ml or mcg/ml. When you enter a new Concentration, the pump requires you to enter a new Continuous Rate, Demand Dose and Delivery Limit.

2.7.3 Continuous Rate

Enter the continuous rate of medication delivery (in mg/hr, ml/hr, or mcg/hr, depending on the Units). The maximum rate is 30 ml/hr or the mg or mcg equivalent. If the prescription does not call for a Continuous Rate, enter zero.

The maximum rate may be limited by the settings made in the Program Limits section of the Biomed Toolbox.

2.7.4 Demand Dose

Enter the amount of drug to be delivered when the patient presses the Remote Dose Cord button. The maximum is 20.0 ml or the mg or mcg equivalent. If the prescription does not call for a Demand Dose, enter zero. The maximum Demand Dose may be limited by the settings in the Program Limits section of the Biomed Toolbox.

2.7.5 Demand Dose Lockout

If you programmed a Demand Dose, enter the minimum amount of time that must elapse between the time one Demand Dose starts and the time the next Demand Dose starts. This lockout period is unaffected by removal of the battery or stopping of the pump.

2.7.6 Max Doses Per Hour

This screen will appear only if the “Max Doses per hour” is selected in the “Dosing Limit” section of the Biomed Toolbox. If you programmed a Demand Dose, enter the maximum number of Demand Doses allowed in any one-hour period. The possible values may be limited by the Demand Dose Lockout time you entered. If the Demand Dose Lockout is one hour or greater, this screen will not appear. The actual lockout time will be determined by either the Demand Dose Lockout or Max Doses Per Hour, whichever is more restrictive. The Max Doses Per Hour limit is unaffected by removal of the battery or stopping of the pump.

NOTE: The number shown on this screen may be outside of the range; this can happen when the Demand Dose Lockout time is changed but the Max Doses Per hour is not adjusted. If you scroll through the numbers, only numbers within this range will appear.

2.7.7 Set Delivery Limit

This screen will only appear if “Delivery Limit” is selected in the Dosing Limit section of the Biomed Toolbox, and hours (1 - 12) was selected in the Delivery Limit Hours screen. Enter the maximum amount of drug (in ml, mg or mcg, depending on units) to be delivered over the time frame displayed. The time

frame is programmable from 1 to 12 hours in the Biomed Toolbox. This feature limits the amount delivered by the Continuous Rate and Demand Dose, but does not limit the amount delivered by a Clinician Bolus. When the limit is reached, the pump automatically begins to deliver fluid at the preset KVO rate for a minimum of 5 minutes.

2.7.8 Reservoir Volume

Enter the volume of fluid in the fluid container. The Reservoir Volume value decreases as the pump delivers fluid or you use the priming feature. When you change the fluid container and reset the Reservoir Volume, the value resets to whatever you enter in this screen. If you do not wish to use the Reservoir Volume feature, scroll down to “Not in Use” (located before 1 and after 9999 in the range of values).

2.7.9 Air Detector Status

This screen appears only if an Air Detector is attached to the pump. It indicates whether the Air Detector is required, turned on, or turned off.

2.8 Programming Example

Medication is provided in a 100 ml Medication Cassette Reservoir at a concentration of 1.0 mg/ml. The patient should receive medication continuously at 5.0 mg/hr. Patient-activated doses of 2.5 mg are allowed, with a 15 minute lockout time between doses, and a Delivery Limit of 100 mg in 4 hours.

In this scenario, the pump would be programmed as follows (for a full description of each screen, see the preceding pages):

1. Begin at the main screen

```
* PCS XXXXX *
          STOPPED
Press VIEW to advance
```





- Make sure the pump is unlocked (LL0).
- Make sure PCS and STOPPED appear on the main screen.
- Press  to begin.

2. Program Units (if applicable).

The Biomed Toolbox allows you to program the display so Units appears here as part of the programming screens, as part of the Biomed Toolbox manu or as part of the Options menu. If Units is part of the Options or Biomed Toolbox menu, you should program Units before continuing with pump programming.

```
Units
⬆ Micrograms
<Range:mg, ml, mcg>
```

```
Change Units to
Milligrams?
Press YES or NO
```

- Press  or  to select desired units in milliliters, milligrams or micrograms. (If Units does not appear, it has been programmed in Biomed Toolbox to be part of the Options menu or the Biomed Toolbox menu.)
- Press .
- Press  to confirm the change.

NOTE: When you change the Units, the pump requires you to enter or verify the Continuous Rate, Demand Dose and Delivery Limit. If Units are mg or mcg, you must also enter Concentration.

3. Enter the Concentration of the drug

This screen will not appear if the units are milliliters; go to step 4.

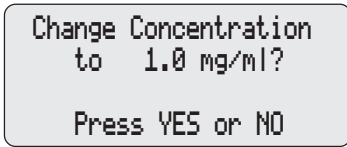
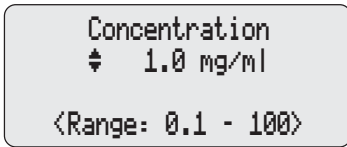

- Press or to select the desired concentration. (If you cannot select the desired concentration, it may have been turned off in the Biomed Toolbox)
- Press .
- Press to confirm the change.
NOTE: If you change the Concentration, you *must* enter the Continuous Rate, Demand Dose and Delivery Limit.

4. Enter the hourly Continuous Rate

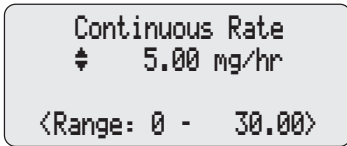



- Press or to select the desired rate.
- Press .
- NOTE:** If “Change Rate to...?” appears, you must confirm the rate because the Units or Concentration was changed, or the rate is greater than or equal to 100 mg/hr or mcg/hr. Press to confirm, or press and re-enter the rate.

NOTE: The pump will not allow you to scroll outside the range displayed.

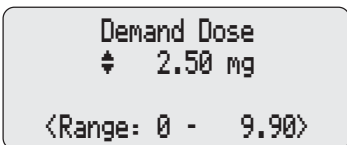
5. Enter the Demand Dose amount



- Press or to select the desired amount.
- Press .
- NOTE:** If “Change Demand Dose to...?” appears, you must confirm



the dose because the Units or Concentration was changed, or the dose is greater than or equal to 100 mg or mcg. Press  to confirm, or press  and re-enter the dose.

NOTE: The pump will not allow you to scroll the dose outside the range displayed.

6. Enter the Demand Dose Lockout time

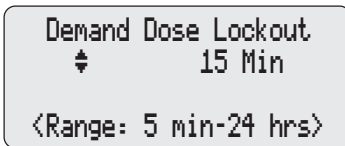
If Demand Dose is zero, this screen will not appear; go to step 8.



- Press  or  to select the desired lockout time between doses.
- Press .

WARNING: When you enter a new Demand Dose Lockout time, any lockout time in effect will be cleared. A Demand Dose could be requested and delivered immediately upon starting the pump, and may result in overdosing, which could cause in death or serious injury to the patient.

7. Max Doses Per Hour

This screen will appear only if the Max Doses Per Hour function is selected in the Dosing Limit section of the Biomed Toolbox, a Demand Dose is programmed and the Demand Dose Lockout is less than 1 hour.

NOTE: The number shown on the screen may be outside of the range; this can happen when the Demand Dose Lockout time is changed but the Max Doses Per Hour number is not adjusted. If you scroll through the numbers,

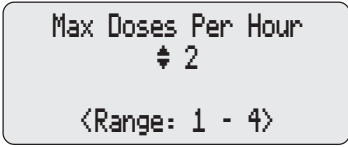

only numbers within the range will appear.

- Press or to select the maximum number of doses per hour.
- Press .

WARNING: When you enter a new Max Doses per Hour value, any lockout time in effect will be cleared. A Demand Dose could be requested and delivered immediately upon starting the pump, resulting in over-delivery, which could result in death or serious injury to the patient.

8. Enter the Delivery Limit

If Delivery Limit is not selected in the Dosing Limit feature in the Biomed Toolbox, this screen will not appear.

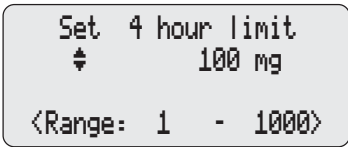

- Press or to select the maximum amount of fluid in time frame.
- Press .

WARNING: With the pump stopped and in LL0 ONLY: Entering a new Delivery Limit will reset the delivery limit feature. When Delivery Limit is reset, any delivery accumulated toward the Delivery Limit is automatically cleared. This will allow delivery to begin as soon as the pump is started, which may result in overdelivery, and could result in death or serious injury to the patient.



```
Change 4 Hr Limit to
100 mg & clear
accumulated limit?
Press YES or NO
```

- Press  to confirm the change and clear accumulated limit value.

NOTE: It may take a moment before the change is entered, as data in pump memory must first be cleared. Watch for <Entering> to appear at the bottom of the screen.

9. Enter the Reservoir Volume

```
Reservoir Volume
  100.0 ml
<Range: 1 - 9999>
```

- Press  or  to select the desired volume. (If you do not wish to use the Reservoir Volume feature, scroll down to “Not In Use” located before 1.)
- Press .



10. Verify the Air Detector status

This screen will appear only if an Air Detector is installed.

```
Air Detector
Required
<Review Only>
```

- Make sure the setting is correct. **NOTE:** If the Air Detector is not required, this screen will show whether it is turned on or off.
- Press  to continue. If you need to correct the Air Detector setting, see Section 4, Options.

11. Review the program

Press  repeatedly to review the programming screens. If you need to reprogram a setting, press  or  until the appropriate screen appears and change the setting as described in this section.

2.9 Removing a Cassette

WARNING: Per general rules of safe practice, always clamp tubing before removing the cassette from the pump. Removing the cassette without closing the clamp could potentially cause unregulated gravity infusion, which could result in patient injury or death.

Make sure the pump is stopped before removing the cassette.

1. Close the tubing clamp.
2. If locked, insert the key and turn the lock clockwise one-quarter turn until it stops.

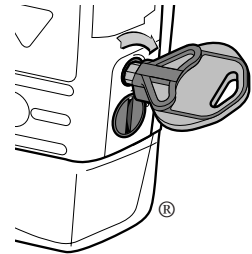

NOTE: If the AutoLock setting (Biomed Toolbox, Section 5) is set to LL1 Key/Code or LL2 Key/Code, using the Cassette / Keypad Lock will automatically unlock the pump program.

3. Use a coin or the side of the key to unlatch the cassette. Insert the coin or side of the key into the slot and turn clockwise until the latching button pops out.

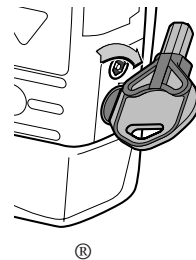

4. Remove the cassette hooks from the pump hinge pins.

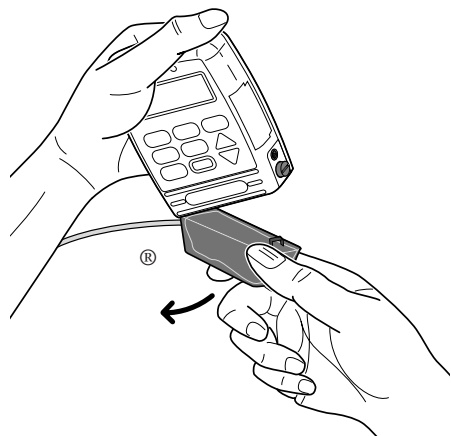

2.10 Attaching a Cassette

Obtain a new, filled Medication Cassette Reservoir, or CADD™ Administration Set attached to a nonvented, flexible IV bag. Refer to the instructions for use supplied with the product for information on preparing the product for use.

Before attaching a new cassette, install a battery or turn pump indicators on as appropriate. When a battery is installed and/or pump indicators are turned on, the pump will automatically display screens which indicate the type of cassette attached, and allow you to reset the Reservoir Volume, prime the fluid path (depending on the lock level), change the lock level (if AutoLock is not in use and the lock level is LL0), and/or start the pump.

NOTE: You can access this sequence of screens even when you are not attaching a cassette. With the pump stopped and the main screen displayed, press **ENTER** to display the sequence beginning with verifying the type of cassette.

CAUTION: If you are using a Medication Cassette Reservoir in which the medication is frozen, thaw at room temperature only. Do not heat in a microwave oven as this may damage the product and cause leakage.

2.10.1 To attach the cassette to the pump

1. Clamp the tubing. Insert the cassette hooks into the hinge pins on the pump.
2. Place the pump upright on a firm, flat surface. Press down so the cassette fits tightly against the pump.
3. Insert a coin or the side of the key into the latch button, push in, and turn counterclockwise until the mark on the latch lines up with the solid dot and you feel the button click into place. A message will appear on the display so you can verify the type of cassette you have attached.

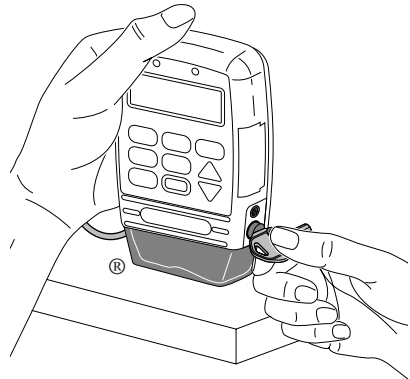

4. Insert the pump key into the lock and turn counterclockwise until the white mark lines up with the solid dot.

NOTE: The cassette **must be locked** in order to start the pump.

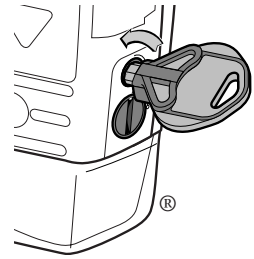

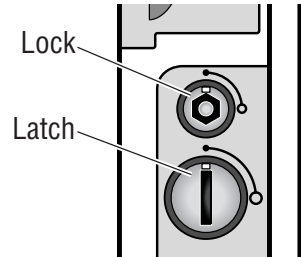

WARNING: Attach the cassette properly. A detached or improperly attached cassette could result in unregulated gravity infusion of medication from the fluid container or a reflux of blood, which could result in death or injury to the patient.

If you are using a Deltec administration set or medication cassette reservoir that does not have the flow stop feature (reorder number does not start with 21-73xx): you must use a CADD™ Extension Set with anti-siphon valve or a CADD™ Administration Set with either an integral or add-on anti-siphon valve to protect against unregulated gravity infusion that can result from an improperly attached cassette. Unregulated gravity infusion can result in death or serious injury.

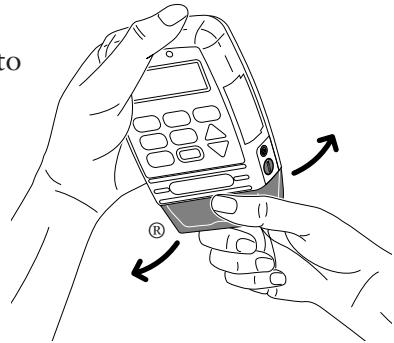

5. Gently twist and pull on the cassette to make sure it is firmly attached.





6. The message “Cassette Locked” will appear on the display. Press .



Cassette Locked

VIEW to continue

7. “Reset Reservoir Volume to...?” may appear.

- To reset Reservoir Volume to the value shown, press .
- To retain the current value, press .

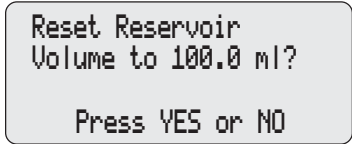

Reset Reservoir
Volume to 100.0 ml?

Press YES or NO

NOTE:



- If this screen does not appear, Reservoir Volume is either already reset or not in use.

2.11 Priming the Tubing and Connecting to the Patient

Prime the tubing *before* connecting it to the patient’s infusion set or indwelling catheter. The pump must be stopped and in LL0 (pump program and keypad completely unlocked) or LL1 (limited access to pump program and keypad) to use the priming feature.

NOTE: When the pump is running, pressing  will access the Clinician Bolus feature.

WARNING: Do not prime the fluid path with the tubing connected to a patient as this could result in overdelivery of medication or air embolism, which could result in serious patient injury or death.

1. With the pump stopped and in LL0 or LL1, press .
2. Make sure the tubing is disconnected from the patient and the tubing clamp is open.
3. Press and hold the  key until the tubing is fully primed or until priming stops.

Disconnect tubing
from patient
Open clamps
Hold YES to prime

Priming...
0.1 ml

Hold YES to prime

NOTE: Fluid delivered during priming is subtracted from the Reservoir Volume, but is not added to the Given screen since this fluid is not delivered to the patient.

4. If the tubing is not yet fully primed, press  and repeat step 3.

Continue Priming?

Press YES or NO

When the tubing is fully primed, press  to exit priming.

5. If an Air Detector is in use, go to the next section. If not, connect the tubing to the patient’s infusion set or indwelling catheter and go to Setting the Lock Level for the Patient.

WARNING: Ensure that the entire fluid path is free of all air bubbles before connecting to the patient to prevent air embolism. Air embolism could result in serious patient injury or death.

NOTE: If the fluid path contains an air eliminating filter, it is acceptable for air bubbles to be present on the vent side of the filter.

2.12 Inserting the Tubing into the Air Detector

WARNING: When the Air Detector is not installed, or is installed but turned off, the pump will not detect air in the fluid path. It is recommended that you periodically inspect the fluid path and remove any air to prevent air embolism. Air embolism could cause serious patient injury or death.

(See Section 5, Biomed Functions, for instructions using the Air Detector, and Section 4, Options, for turning the Air Detector On or Off.)

1. If the Air Detector is in use, open the Air Detector door and thread the tubing through the groove.
2. Close the door, making sure the tubing does not get pinched or kinked.
3. Connect to the patient's infusion set or indwelling catheter.

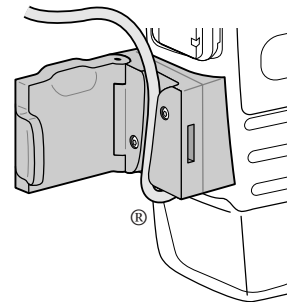

WARNING: Ensure that the entire fluid path is free of all air bubbles before connecting to the patient to prevent air embolism. Air embolism could cause serious patient injury or death.

NOTE: If the fluid path contains an air eliminating filter, it is acceptable for air bubbles to be present on the vent side of the filter.

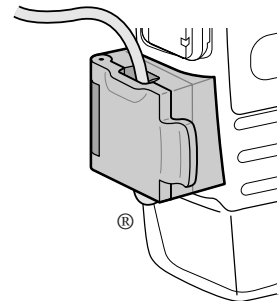

2.13 Locking the Pump Program for the Patient

The Lock Level must be reset to LL1 (limited access to pump program and keypad) or LL2 (minimal access to pump program, keypad is locked) to prevent the patient from having complete access to all programming and operating functions. If **Autolock is in use**, the pump will automatically lock the pump program to LL1 or LL2 as part of the routine when you press .



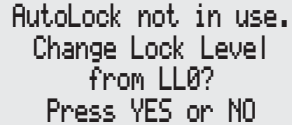



If AutoLock is not in use and the lock level is LL0 when you attach a cassette, this message will appear in the sequence of screens to allow you to set the lock level to LL1 or LL2. For detailed information on lock levels, see Lock Levels, Section 1.



AutoLock not in use.
Change Lock Level
from LL0?
Press YES or NO

NOTE: You may change the lock level at any time, whether the pump is running or stopped, by accessing the Lock Level function in the Options menu.

2.13.1 To change the lock level when Autolock is not in use

- With this message displayed, press . (If you do not wish to change the lock level at this time, press  and go to the next page.)
- The current lock level will appear.
- Press  or  until the desired lock level (LL1 or LL2) appears.
- Press . “000” will appear.
NOTE: If <Custom> appears, the Lock Level Code has been customized. Use the custom Lock Level Code in the next step.
- Press  or  until the Lock Level Code **** Text Omitted ****

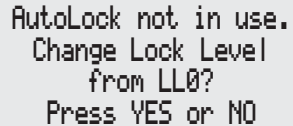

AutoLock not in use.
Change Lock Level
from LL0?
Press YES or NO



Lock Level
LL0



Lock Level
LL1



Lock Level Code
000



Lock Level Code

WARNING: Do not disclose to the patient the pump's security codes or any other information that would allow the patient complete access to all programming and operating functions. Improper programming could result in serious patient injury or death.

6. Press  to set the new lock level. Watch the display to verify that the correct lock level is being entered.

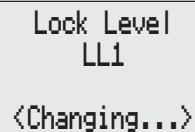

```
Lock Level
LL1
<Changing...>
```

2.14 Remote Dose Cord

The patient uses the button on the Remote Dose Cord to start a Demand Dose. For easy access, the Remote Dose Cord may be fastened to the patient's clothing or bed sheet with the attached clip.

WARNING: Do not place the Remote Dose Cord where the button might accidentally be pushed. Accidentally pushing the button may deliver an inadvertent Demand Dose, which could result in serious patient injury or death.

CAUTIONS:

- Do not use the Remote Dose Cord to pick up or carry the pump. Using the cord in this manner could damage the pump or cord.
- To avoid damaging the connector or cord, do not use excessive force or instruments, such as pliers, to remove the Remote Dose Cord from the pump.

2.14.1 To attach the Remote Dose Cord

1. Open the cover over the Data In/Out jack.
2. Line up the red mark on the Remote Dose Cord connector with the red mark on the pump. Push the connector in until it clicks.

NOTE: The cord may or may not be supplied with the grip shown in this illustration.

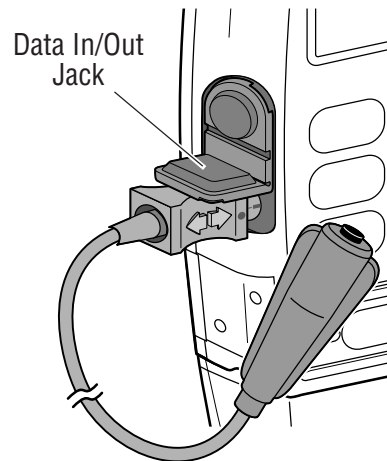

2.14.2 To detach the Remote Dose Cord

1. Grasp the collar on the connector.
2. Pull the connector back using a straight, steady motion. DO NOT twist or turn the connector.

2.15 Starting the Pump

1. This is the last screen to appear when you latch and lock a cassette. If the fluid path is free of air and the tubing is attached to the patient, press  to start the pump.

Start the Pump?

Press YES or NO

2. “Starting Pump” will appear.

The pump will review the program, lock level, AutoLock setting, time, date, dose counters and given. If AutoLock is in use, “AutoLock is locking keypad” will appear.

Starting Pump...

After the automatic review, “RUNNING” will appear on the main screen, the green indicator light will blink, and fluid delivery will begin as programmed.

2.16 Adjusting Patient Delivery (Titration)

If the prescription allows, the Continuous Rate, Demand Dose and Delivery Limit can be easily adjusted (titrated) during the course of therapy. Titration can be accomplished in LL1 (limited access to pump program and keypad) while the pump is stopped, and in LL0 (pump program and keypad completely unlocked) or LL1 while the pump is running.





The titration amounts allowed are dependent on the values last programmed (with the pump in LL0) for these parameters, and the Titration Limit (programmed in the Biomed Toolbox). The Titration Limit feature sets a maximum percentage change allowed while the pump is stopped and in LL1, and while the pump is running and in LL0 and LL1.

The following table illustrates this feature for a Titration Limit set at 25 percent.

	LL0 Programmed Value	Titration Limit while pump is: • Stopped in LL1 • Running in LL0 or LL1
Continuous Rate	10 mg/hr	12.5 mg/hr
Demand Dose	5 mg	6.25 mg
(4 hr) Delivery Limit	100 mg	125 mg

2.16.1 Titrating while the pump is running

If the pump is running in LL0 (pump program and keypad completely unlocked) or LL1 (limited access to pump program and keypad):

1. Press  until the parameter you want to titrate appears (Continuous Rate, Demand Dose, or Delivery Limit).
2. Press  or  to scroll to the desired value, then press .

If the pump is running in LL2 (minimal access to pump program, keypad is locked), you must first unlock the pump program. This can be accomplished without stopping the pump if the AutoLock feature is set to one of the Key/Code settings - use the Cassette / Keypad Lock Key to unlock the cassette - this will automatically unlock the pump program. (Or, change the Lock Level setting in the Options menu.)

Once you have titrated the desired value, use the Cassette / Keypad Lock Key

Section 2: Pump Setup and Programming

to relock the cassette to relock the pump program (or, change the Lock Level setting in the Options menu.)

Section 3: Operating the Pump

3.1 Stopping the Pump

Stopping the pump stops delivery. “STOPPED” will appear on the main screen and the amber indicator light will blink.

3.1.1 To stop the pump

1. Press .

If a Demand Dose or Clinician Bolus is in progress, “Stop Demand Dose?” or “Stop Clinician Bolus?” will appear.



Press  to stop the dose.

2. When “Stop the Pump?” appears, press .

Stop the Pump?

Press YES or NO

3.1.2 To turn pump indicators off

1. When “Turn indicators off?” screen appears, press  to turn pump indicators off, or press  to leave pump on.
2. Once pump indicators are turned off, you can press any key to turn them back on. The pump will complete its power-up sequence (see Power Up, Section 2.2).

Turn indicators off?
Press YES or NO
(press any key to
turn indicators on)

3.2 Starting the Pump

When you start the pump, programmed values will be automatically reviewed. Then fluid delivery will begin as programmed, RUNNING will appear on the

main screen, and the green indicator light will blink. **If the pump will not start**, a message will appear on the display. Refer to the Messages and Alarms Table in Section 6.

3.2.1 To start the pump

1. Press .

Start the Pump?
Press YES or NO
Turn indicators off?
Press ENTER

2. Press  to start the pump. “Starting Pump” will appear.

Starting pump...

The pump will review the program, lock level, AutoLock setting, Air Detector status, time, date, dose counters and given.

If AutoLock is in use, “Lock Level <Locking...>” will appear.

Autolock is locking keypad

3.2.2 To turn pump indicators off

1. If you want to turn pump indicators off, at this screen press .

Start the Pump?
Press YES or NO
Turn indicators off?
Press ENTER

2. Press  to turn pump indicators off.

3. Once pump indicators are turned off, you can press any key to turn them back on. The pump will complete its power-up sequence (see Power Up, Section 2.2).



Turn indicators off?
Press YES or NO
(press any key to turn indicators on)

3.3 Starting a Clinician Bolus

A Clinician Bolus may be delivered while the pump is running. It allows you to deliver a specified amount of drug, for example, as a loading dose. Lockout settings have no affect on Clinician Bolus frequency. However, a Clinician Bolus cannot be started while a Demand Dose is in progress. The amount delivered decreases the Reservoir Volume and increases the Given amount, but does not add to the Dose Counters. A Clinician Bolus may be stopped in progress.

WARNING: Exercise care when using the Clinician Bolus function. Since there are no limits on the frequency of delivering a bolus, and since the amount of the bolus can be set as high as 20 ml (or the mg or mcg equivalent), you should not permit the patient to become familiar with the procedure for giving a Clinician Bolus. Improper programming could result in serious patient injury or death.

3.3.1 To start a Clinician Bolus

1. Make sure the pump is running. Start the pump if necessary.
2. Press .
3. Press  until the Clinician Bolus Code **** Text omitted **** appears.



NOTE: If <Custom> appears, the Clinician Bolus Code has been customized. Use the custom Clinician Bolus Code.

4. Press .



Clinician Bolus Code

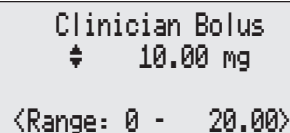

WARNING: To prevent the patient from accessing the Clinician Bolus function, do not let the patient know this code. Improper programming could result in serious patient injury or death.

5. Press  or  to select the desired amount.
6. Press .



Clinician Bolus
10.00 mg
<Range: 0 - 20.00>

NOTE: If you enter a value greater

than or equal to 100 mg or mcg, a screen will appear asking you to confirm the value. Press  to confirm, or  to re-enter the value.

7. The screen will show the amount decreasing as the bolus is delivered.

NOTE: The maximum Clinician Bolus may be limited by the settings in the Program Limits section of the Biomed Toolbox.

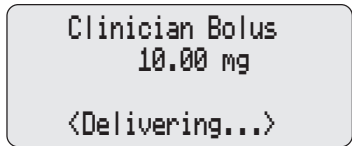

Clinician Bolus
10.00 mg
<Delivering...>

3.4 Starting a Demand Dose

If a Demand Dose has been programmed, the patient may start a Demand Dose while the pump is running. The amount delivered is added to the amount provided by the Continuous Rate. Each time the patient requests a Demand Dose, the pump will automatically add it to the Dose Counters screen. If no Demand Dose has been programmed, the pump will display the message “Dose not delivered, No Dose programmed.”

If the patient attempts to deliver a Demand Dose during the lockout time, “Dose Not Delivered, Dose Locked Out” will appear on the display and the pump will not deliver the dose. The lockout time is determined by the Demand Dose Lockout time.

With a Continuous Rate programmed, if the patient attempts to deliver a Demand Dose when the Delivery Limit has been reached, “Delivery Limit reached. Current Delivery at KVO (.1 ml/hr)” will appear on the display and the dose will not be delivered. With no Continuous Rate programmed, the message is “Delivery Limit reached / No Rate, delivery at 0.0 ml/hr.”

NOTES:

- If the Delivery Limit is reached while a Demand Dose is in progress, the Demand Dose will be completed.
- A Demand Dose cannot be started while another Demand Dose or a Clinician Bolus is in progress.
- Even if the display has automatically blanked, pressing the Remote Dose Cord button will turn the display back on and deliver a Demand Dose (if available).

3.4.1 To start a Demand Dose

1. Make sure the pump is running. Start the pump if necessary.
2. Press the button on the Remote Dose Cord. Two beeps will sound and the pump will begin delivering the Demand Dose.



Demand Dose
Started
VIEW to continue





As the Demand Dose is delivered, the main screen will show “DOSING” in place of “RUNNING.”

```
* PCS XXXXX *  
Low Battery   DOSING  
Res Vol      47.0 ml  
Press VIEW to advance
```

3.5 Stopping a Demand Dose or Clinician Bolus

A Demand Dose or Clinician Bolus can be stopped in progress. The pump may be in any lock level. A Demand Dose that has been stopped will remain recorded on the Dose Counter screen under “Given/Attempt.”

3.5.1 To stop a dose while the pump is running

1. Press . One beep will sound and the message “Stop Demand Dose?” or “Stop Clinician Bolus?” will appear.
2. Press  to stop the dose and to cancel the remainder of the dose. “Demand Dose Stopped” or “Clinician Bolus Stopped” will appear.
3. When “Stop the Pump?” appears,
 - press  to remain running, or
 - press  to stop the pump.

Stop Demand Dose?

Press YES or NO

Demand Dose
Stopped

Stop the Pump?

Press YES or NO

3.6 Resetting the Reservoir Volume

3.6.1 Resetting Reservoir Volume without changing the cassette

Normally, when you latch and lock a cassette onto the pump as described in Section 2, a series of messages lead you through resetting the Reservoir Volume, priming the tubing, (except in LL2), and starting the pump.

You can, however, reset the Reservoir Volume without changing the cassette using the Reservoir Volume programming screen. The pump must be stopped and in any lock level.

1. Stop the pump.
2. Press **BACK** to display the Reservoir Volume screen.
3. Press **ENTER**.
4. When this message appears, press  to reset the Reservoir Volume. (If this message does not appear, the Reservoir Volume is either already reset or is not in use.)

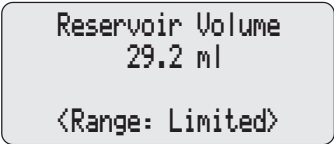

```
Reservoir Volume
29.2 ml
```

```
<Range: Limited>
```



```
Reset Reservoir
Volume to 100.0 ml?
```

```
Press YES or NO
```

Section 4: Options

4.1 Overview: Accessing Options

The Options menu allows access to other pump features and settings.

- If the pump is stopped the availability of an option may depend on Biomed Toolbox settings, the presence of an air detector and whether the pump program is locked or unlocked.
- If the pump is running the only optional function available is the locking and unlocking of the pump program using the keypad.

4.1.1 To access Options

1. With the pump stopped, start at any screen and press **OPTIONS**.
2. Use **YES**, **NO**, **OPTIONS** or **BACK** to page through the Options. To select an Option, make sure it is displayed on the Options Menu and press **ENTER**.

The **⚡** symbol means you may use the **YES** or **NO** key to see more Options.

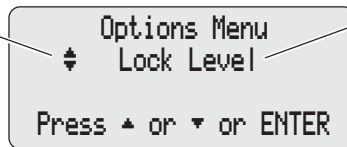

Options appear here. In this example, the “Lock Level” option is shown. To select the option shown, press **ENTER**. To see other options, press **YES**, **NO**, **OPTIONS** or **BACK**.





3. To exit the Options Menu, press **VIEW SILENCE** until you return to the main screen.



4.2 Lock Level

You may view or program the pump’s lock status at any time, with the pump running or stopped, from the Options Menu if the Autolock feature is not in use. If you wish to use the AutoLock feature, see Section 5, Biomed Toolbox.

4.2.1 To change Lock Level

1. Press .

If necessary, press ,  or  until “Lock Level” appears. Then press .

2. Press  or  until the desired Lock Level appears, then press  and “000” will appear.

NOTE: If <Custom> appears on the screen, the Lock Level Code has been customized. Enter the Custom Lock Level Code in the next step.

3. Press  or  until the Lock Level Code **** Text Omitted **** appears.

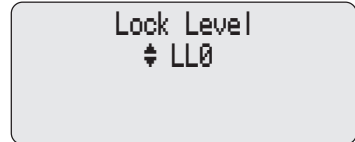
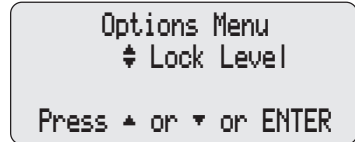

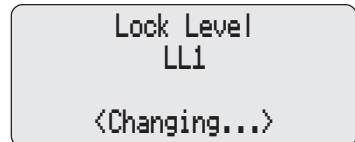

WARNING: Do not disclose to the patient the pump’s security codes or any other information that would allow the patient complete access to all programming and operating functions. Improper programming could result in serious patient injury or death.

4. Press  to set the new Lock Level. Watch the display to verify that the correct Lock Level is being entered. If you do not see this message, the Lock Level has not been changed. Repeat the above steps.



4.3 Epidural Mode

When the **Epidural Mode** Option is turned On, and a cassette is attached to the pump or the pump is powered up with a cassette attached, one of the messages at right appears in the display. You must confirm that an epidural cassette is attached.

If you press , an alarm will sound and the message at right will appear in the display. If you press , programming will continue.

The pump does not require that a particular cassette be used (Smiths Medical MD recommends that your institution designate a particular type or color of cassette as Epidural).

Epidural will also be displayed in the main screen (or a 21-character message defined by the user).

NOTE: The 21-character customized message can only be developed by the user with the CADD-Diplomat® Communications Program, sold separately by Smiths Medical MD, Inc.

WARNING:

- Do not administer drugs to the epidural space or subarachnoid space unless the drug is indicated for administration to the those spaces. Drugs not intended for epidural or subarachnoid space infusion could result in serious patient injury or death.
 - To prevent the infusion of drugs that are not indicated for epidural space or subarachnoid space infusion, DO NOT use administration sets that incorporate injection sites. The inadvertent use of injection sites for infusion of such drugs may cause serious patient injury or death.
 - If a Medication Cassette Reservoir, CADD™ Extension Set or CADD™ Administration Set is used for epidural space or subarachnoid space drug delivery, it is strongly recommended that it be clearly differentiated from those used for other routes of infusion, for example, by color coding, or other means of identification. Drugs not intended for epidural or subarachnoid space infusion could result in serious patient injury or death.
-
-

Reservoir latched
Is epidural reservoir
attached?
Press Yes or No

Admin set latched
Is epidural admin set
attached? <Yes or No>

Non-Epidural cassette
attached. Remove
Cassette to continue.

4.3.1 To turn Epidural Mode On or Off

2. Press **OPTIONS**.
Press **YES**, **NO** or **OPTIONS** until “Epidural Mode” appears. Then press **ENTER**.
3. Press **YES** or **NO** to select the desired setting, then press **ENTER**.

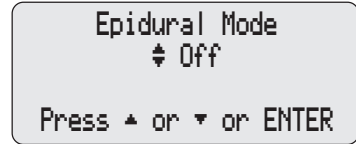
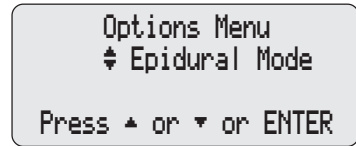

4.4 Programming Units

The **Programming Units** Option shows the type of programming units selected. Possible Units settings are milliliters, milligrams and micrograms. Biomed Toolbox allows you to make Programming Units part of the Options menu, Biomed Toolbox menu or part of the programming screens. This section assumes the Programming Units has been programmed to be part of the Options menu.

4.4.1 To change Units

1. Press **OPTIONS**. Press **YES** or **NO** until “Programming Units” appears.
2. To change the setting, press **ENTER**.
3. Press **YES** or **NO** to select the desired units, then press **ENTER**.
4. Press **YES** to confirm the change.

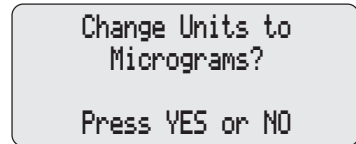
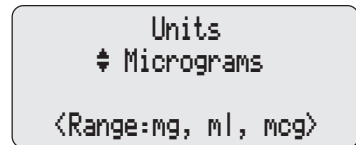
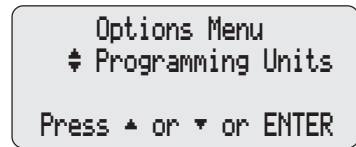

The pump will then automatically take you into the programming screens to verify and/or enter the Concentration, Continuous Rate, Demand Dose and Delivery Limit.

NOTE: The units screen will not appear if only one unit type has been programmed in the “Units Selection” feature in the Biomed Toolbox. The range in

the Units screen will display “custom” if two units have been selected in the Units Selection feature. The scroll range on the Units screen will include only the selected units.

4.5 Time

The **Time** Option shows the time of day in 24-hour (military) time according to the pump’s internal clock. The clock is powered by a separate, internal battery which retains the time even when the 9 volt battery is removed. The time is used to record the time of events in the Pain Scale Log, Delivery Log and Event Log.

WARNINGS:

- If Demand Doses are currently locked out, changing the Time will cancel the lockout period. This will allow a Demand Dose to be requested and delivered as soon as you restart the pump, resulting in overdelivery, which could result in serious patient injury or death.
- Changing the Time will reset the Delivery Limit feature. This will allow delivery to begin as soon as the pump is restarted, resulting in overdelivery, which could result in serious patient injury or death.

NOTE: Changing the time will clear Doses Hour by Hour and parts of Patient Review (Demand Dose, Clinician Bolus and Given).

4.5.1 To change the Time of Day

To view the setting, the pump may be in any lock level. To change the setting, the pump must be stopped and in LL0 (pump program and keypad completely unlocked).

1. Press **OPTIONS**. Press **▲** or **▼** until “Time” appears with the time setting.
2. To change the setting, press **ENTER**. A message will appear notifying you of other settings that will be affected by changing the time. This message will clear in a few seconds.
3. Press **▲** or **▼** to select the desired time in **24-hour military time**, then press **ENTER**.

```
Options Menu
  ⚡ Time  14:45
Press ▲ or ▼ or ENTER
```

```
Changing time will
clear previous
patient records and
delivery lockouts
```

```
Time of Day
  ⚡ 15:45
Press ▲ or ▼ or ENTER
```

4. Press  to confirm the change.

NOTE: It may take a moment before the change is entered, as data in pump memory must first be cleared. Watch for <Entering> to appear at the bottom of the screen.

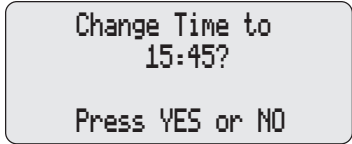

4.6 Date

The Date Option should reflect the current date. This feature is used to record the date of events in the Pain Scale Log, Delivery Log and Event Log.



WARNINGS:

- If Demand Doses are currently locked out, changing the Date will cancel the lockout period. This will allow a Demand Dose to be requested and delivered as soon as you restart the pump, resulting in overdelivery, which could result in serious patient injury or death.
- Changing the Date will reset the Delivery Limit feature. This will allow delivery to begin as soon as the pump is restarted, resulting in overdelivery, which could result in serious patient injury or death.

NOTE: Changing the date will clear Doses Hour by Hour and parts of Patient Review (Demand Dose, Clinician Bolus and Given).

4.6.1 To change the Date

To view the setting, the pump may be in any lock level. To change the setting, the pump must be stopped and in LL0 (pump program and keypad completely unlocked).

1. Press . Press  or  until “Date” appears with the date setting.

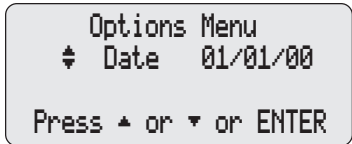

2. To change the setting, press . A message will appear to notify you of other settings that will be affected by changing the date. This message will clear in a few seconds.



3. Press  or  to select the date, then press .

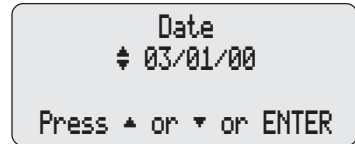

4. Press  to confirm the change.

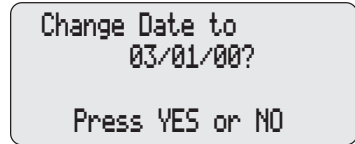

NOTE: It may take a moment before the change is entered, as data in pump memory must first be cleared. Watch for <Entering> to appear at the bottom of the screen.

4.7 Air Detector On/Off

The **Air Detector** Option controls whether the Air Detector is turned on or off. This option appears in the menu only if an Air Detector is installed on the pump and is not required. (A setting in the Biomed Toolbox controls whether an Air Detector is required. If the Air Detector is required, you are not allowed to turn it off and this option will not appear in the menu.) The Air Detector Option can be set to “Turned On” or “Turned Off.” If the Air Detector is turned on, an alarm will sound when air is detected in the fluid path. (See Section 6 for Air Detector specifications.)







WARNING: When the Air Detector is installed but turned off, the pump will not detect air in the fluid path. It is recommended that you periodically inspect the fluid path and remove any air to prevent air embolism. Air embolism could cause serious patient injury or death.

When the Air Detector is first attached to the pump, the Air Detector screen defaults to “Turned On.” This screen also changes to “Turned On” each time the pump powers up in Lock Level 0.

For certain therapies, it may be desirable to turn the Air Detector off (for example, for epidural infusion or subcutaneous infusion).

4.7.1 To change the Air Detector setting

To view the setting, the pump may be in any lock level. To change the setting, the pump must be stopped and in LL0 (pump program and keypad completely unlocked).

1. Press **OPTIONS**. Press  or  until “Air Detector” appears, then press .
2. The current setting will appear. To change the setting, press  or  to select the desired setting, then press .
3. Press  to confirm the change.

```
Options Menu
  ⚡ Air Detector
Press ▲ or ▼ or ENTER
```

```
Air Detector
  ⚡ Turned On
Press ▲ or ▼ or ENTER
```

```
Change Air Detector
to Turned On?
Press YES or NO
```

Section 5: Biomed Toolbox

5.1 Overview: Accessing the Biomed Toolbox

The Biomed Toolbox contains pump configurations that are less frequently changed. The Biomed Toolbox is accessible only when the pump is stopped and unlocked.

5.1.1 To Access the Biomed Toolbox Menu

1. Press **OPTIONS**. Press **▲** or **▼** until “Biomed Toolbox” appears, then press **ENTER**.
2. Press **▲** or **▼** until the Biomed Toolbox Code **** Omitted **** appears. Then press **ENTER**.

```
Options Menu
↓ Biomed Toolbox
Press ▲ or ▼ or ENTER
```

```
Biomed Toolbox Code
***
```

WARNING: Do not disclose to the patient the pump’s security codes or any other information that would allow the patient complete access to all programming and operating functions. Improper programming could result in serious patient injury or death.

**** Text Omitted ****



Press **▲** or **▼** to scroll through the Biomed Toolbox Menu, then press **ENTER** to access the editing screens. Follow the instructions on the following pages for the appropriate screen. To exit the editing screens without changing a setting, press **VIEW SILENCE**. From the Biomed Toolbox Menu, press **VIEW SILENCE** to exit back to the Options menu. The **BACK** key is not active in the Biomed Toolbox.

```
Biomed Toolbox Menu
↓ Air Detector Req [ ]
Press ▲ or ▼ or ENTER
```





5.2 Custom Concentrations

This screen allows you to select the concentrations that will be available for programming in the Concentration screen (mg/ml or mcg/ml). You may turn on or turn off all concentrations, except the currently programmed concentration. Then you can selectively turn on or turn off individual concentrations. For example, if only three concentrations will be used, you can turn off all concentrations, then turn on those three concentrations. **At least one concentration must be on.**

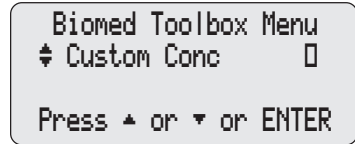
Since you cannot turn off the currently programmed concentration, you may want to change the Units programming screen to milliliters before customizing concentrations.



1. At the Biomed Toolbox Menu, press  or  until “Custom Conc” appears. If an X appears in the box, concentrations for either mg or mcg are currently customized.



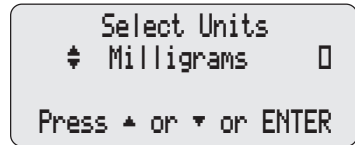



2. To view or customize concentrations, press .
3. Press  or  to select the units (milligrams or micrograms) you wish to customize, then press .

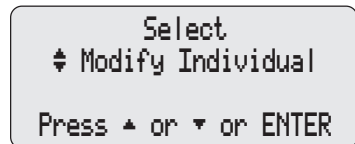

If an X appears in the box, concentrations for these units have been customized.

4. Press  or  to select one of the following, then press .
- **Turn On All** (this will turn on all concentrations).
 - **Turn Off All** (this will turn off all concentrations except the currently programmed concentration).
 - **Modify Individual** (this allows you to selectively turn on or turn off concentrations).



5. Turn individual concentrations on or off as appropriate:
 - Press  or  to select the concentration.
 - Press  to turn the concentration on or off.
 - Repeat as necessary. When finished, or to leave the settings unchanged, press  to return to the Biomed Toolbox menu.







```
Select Concentration
  2.0 mg/ml Off
ENTER to turn on
```

NOTE:

- It may take a moment before the change is entered, as data in pump memory must first be cleared. Watch for <Entering> to appear at the bottom of the screen.
- If you try to exit with all concentrations turned off, a message will appear reminding you that at least one concentration must be turned on.

5.3 Dosing Limit

This feature allows the user to limit the dosing by selecting a Delivery Limit, a Maximum Doses per Hour, or neither. If the Max Doses Per Hour function is not selected, doses will be limited only by Demand Dose Lockout time. When Max Doses per Hour is changed, any Dose Lockout time will be cleared. If the Delivery Limit feature is not selected, the Delivery Limit screen in the programming screens as indicated in section 5.4 will not appear. If you choose Neither, doses will be limited only by Demand Dose Lockout time. The default setting is Neither.

1. At the Biomed Toolbox Menu, press  or  until “Dosing Limit” appears.
2. To change the setting, press . Press  or  to select the desired setting, then press .

```
Biomed Toolbox Menu
  Dosing Limit
Press ▲ or ▼ or ENTER
```

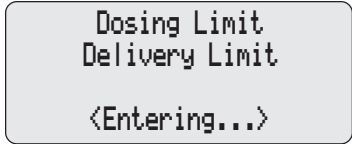

```
Dosing Limit
  Delivery Limit
Press ▲ or ▼ or ENTER
```

The new setting is entered.





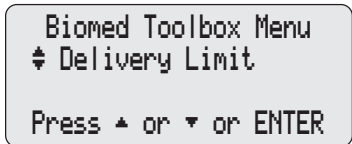

5.4 Delivery Limit

If you have selected Delivery Limit in Dosing Limit (above), this screen will appear. The Delivery Limit feature limits the amount that can be delivered by the Continuous Rate and Demand Dose in a programmable 1 to 12 hour period. The default time period is 4 hours, but can be set anywhere from 1 to 12 hours in 1 hour increments.

1. At the Biomed Toolbox Menu, press  or  until “Delivery Limit” appears.



2. To change the setting, press . Press  or  to select the desired setting, then press .

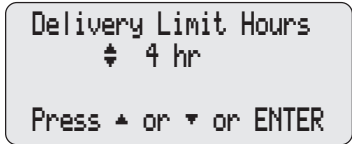





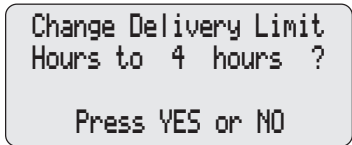

3. Press  to confirm the change.

NOTE: It may take a moment before the change is entered, as data in pump memory must first be cleared. Watch for <Entering> to appear at the bottom of the screen.



5.5 Program Limits

Program Limits allows you to configure the maximum program limits for Demand Dose, Continuous Rate and Clinician Bolus. The maximum program limits can be configured for each programming unit (mg, mcg, ml). The programming increment for each program limit is 0.1 ml. If the maximum program limit is below the minimum increment for a given concentration the feature will not scroll. If a current programmed value for a parameter is outside a newly programmed maximum limit, the values (Continuous Rate and/or Demand Dose) will be set to zero.

1. At the Biomed Toolbox Menu, press  or  until “Program Limits” appears.
2. To change the setting, press .
3. Press  or  to select the desired setting, then press .

NOTE: See Table 6.9 in Section 6 for a complete list of Program Limit ranges and increments for units and concentration programming.

NOTE: Once you enter the program limits screens you will be required to go through all the screens. To leave a setting unchanged press .





```
Biomed Toolbox Menu
┆ Program Limits
Press ▲ or ▼ or ENTER
```

```
Max Demand Dose
┆ 1000.00 mg
<Range: 0 - 2000.00>
```

```
Max Demand Dose mg
1000.00 mg
<Entering...>
```

5.6 Maximum Delivery Rate

The Maximum Delivery Rate feature allows you to program the maximum rate at which the pump will deliver (excluding the rate during priming). The maximum rate is the sum of the Continuous Rate and either Demand Dose or Clinician Bolus rate. For example, if the Maximum Delivery Rate is programmed to 60 ml/hr, and the Continuous Rate is programmed to 15 ml/hr, a Demand Dose or Clinician Bolus would be delivered at 45 ml/hr. The Maximum Rate is programmable from 40 to 125 ml/hr in increments of 1 ml/hr. The default value is 125 ml/hr.

1. At the Biomed Toolbox Menu, press  or  until “Max Delivery Rate” appears.
2. To change the setting, press .
3. Press  to confirm change.







```
Biomed Toolbox Menu
┆ Max Delivery Rate
Press ▲ or ▼ or ENTER
```

```
Max Delivery Rate
┆ 60 ml/hr
Press ▲ or ▼ or ENTER
```

```
Change Maximum
Delivery Rate to
60 ml/hr ?
Press YES or NO
```

5.7 Key Beeps





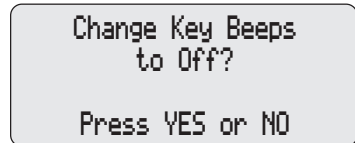
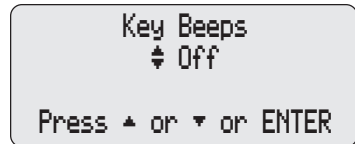
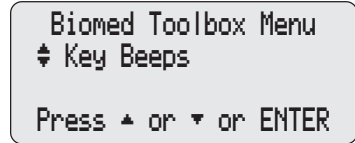

This screen allows you to turn off the audible beep which accompanies each key press. This feature *does not* turn off any audible alarms associated with alarm or alert conditions of the pump. The default setting is On.

1. At the Biomed Toolbox Menu, press  or  until “Key Beeps” appears.
2. To change Key Beeps, press . Press  or  to select the setting. Then press .
3. Press  to confirm change.



5.8 Res Vol Trip Point

The Res Vol Trip Point allows you to program the pump to alarm when the Reservoir Volume reaches a specified level. Once activated, the alarm continues to sound until cleared, or until the Res Vol reaches zero. If this feature is turned on, the standard Res Vol alarm will be disabled (pump signals “Res Vol Low” initially when Res Vol reaches 5 ml, and at every delivery of 1 ml thereafter). The Res Vol Alert is programmable from 1 to 999 ml in 1 ml increments, or “Standard” (located before 1 and after 999). The default setting is “Standard.”

1. At the Biomed Toolbox Menu, press  or  until “Res Vol Trip Point” appears.
2. To change the Res Vol Trip Point, or to disable it, press . Press  or  to select the desired value. Then press .

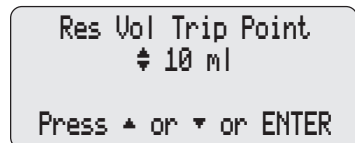
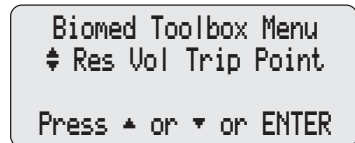

3. Press  to confirm change.



Change Res Vol Trip
Point to 10 ml?



Press YES or NO

Biomed Toolbox Menu
⬆ Titration Limit

Press ▲ or ▼ or ENTER





5.9 Res Vol Empty Alarm

The Res Vol Empty Alarm allows you to select either a Single or Insistent alarm when the Res Vol is empty. When Insistent is selected and the Res Vol Empty alarm occurs, the pump sounds a two-tone alarm and you will be required to press  to silence the alarm. The alarm is repeated every 5 minutes until the Res Vol has been set to a new value, the reservoir is removed, the pump is powered down or pump indicators are turned off. When Single is selected and the Res Vol Empty alarm occurs, the pump sounds a continuous beep, you will again be required to press the  key to silence the alarm, however the alarm will not reoccur. The default setting is Single.

1. At the Biomed Toolbox Menu, press  or  until “Res Vol Empty Alarm” appears.

Biomed Toolbox Menu
⬆ Res Vol Empty Alarm

Press ▲ or ▼ or ENTER

2. To change the setting, press . Press  or  to select the desired value. Then press .

Res Vol Empty Alarm
⬆ Insistent

Press ▲ or ▼ or ENTER







Res Vol Empty Alarm
Insistent

<Entering...>

5.10 Pump Stopped Alarm

The Pump Stopped Alarm allows you to select either a Beep or Two-Tone alarm when the pump is stopped. When Two-Tone is selected and the pump is left in the stop mode for 5 minutes, the Pump Stopped alarm occurs, the pump sounds a two-tone alarm and you will be required to press  to silence the alarm. The alarm is repeated every 5 minutes until the pump is started, the





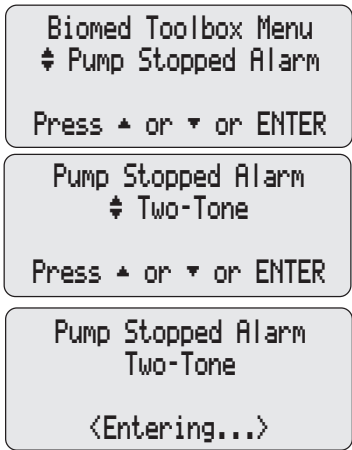

pump is powered down or the indicators are turned off. When Beep is selected the pump will beep every 5 minutes. The default is Beep.

1. At the Biomed Toolbox Menu, press  or  until “Res Vol Empty Alarm” appears.
2. To change the setting, press . Press  or  to select the desired value. Then press .



5.11 Titration Limit

This screen allows you to set the titration limits for Continuous Rate, Demand Dose and Delivery Limit. The titration limit value is programmed as a percentage. It indicates the percentage change you could titrate from the original value which was programmed while the pump was stopped and unlocked. The Titration Limit range is 1 to 300 percent in 1 percent increments. Scrolling below 1 displays “No Titration” which, if selected, would disable the feature. Scrolling above 300 displays “No Limit” which, if selected, would allow you to titrate the values without limit.

1. At the Biomed Toolbox Menu, press  or  until “Titration Limit” appears.
2. To change the setting, press . Press  or  to select the desired value. Then press .
3. Press  to confirm change.

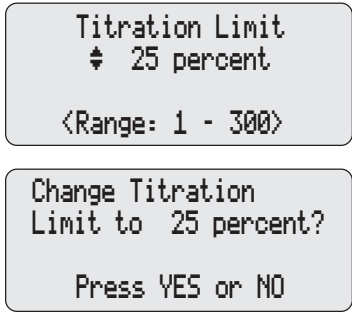

5.12 AutoLock



The AutoLock feature automatically changes the Lock Level from LL0 to LL1 or LL2 when the pump is started, instead of requiring you to manually change the Lock Level. AutoLock may be set to LL1 Key/Code, LL2 Key/Code, LL1 No Key, LL2 No Key or “Not in Use.”

- **Not In Use** - AutoLock will not change the Lock Level. The Cassette / Keypad Lock will not change the Lock Level.
- **LL1 Key/Code** - AutoLock will raise the Lock Level to LL1 (limited access to pump program and keypad) when the pump begins running. With the pump stopped, unlocking the cassette with the Cassette / Keypad Lock will change the Lock Level to LL0 (pump program and keypad completely unlocked).
- **LL2 Key/Code** - with the pump stopped, AutoLock will raise the Lock Level to LL2 (minimal access to pump program, keypad is locked) when the pump begins running. With the pump running, the Cassette / Keypad Lock will change the Lock Level to LL1 when used to unlock the cassette, and then back to LL2 when the cassette is locked. With the pump stopped, the Cassette / Keypad Lock will change the Lock Level to LL0 when used to unlock the cassette.
- **LL1 No Key** - AutoLock will raise the Lock Level to LL1 when the pump begins running. The Cassette / Keypad Lock will not change the Lock Level.
- **LL2 No Key** - AutoLock will raise the Lock Level to LL2 when the pump begins running. The Cassette / Keypad Lock will not change the Lock Level.

AutoLock takes effect when you start the pump in LL0 only. It *will not* change the Lock Level if you manually set the Lock Level to LL1 or LL2 and then start the pump.

IMPORTANT: Changing the AutoLock setting is not the same as changing the Lock Level. AutoLock specifies the Lock Level the pump will switch to when you start the pump in LL0. To manually change the pump’s Lock Level, see Section 4, Options.

To view or change the AutoLock Setting:

1. At the Biomed Toolbox Menu, press  or  until “AutoLock” appears.

Biomed Toolbox Menu
 ⚡ AutoLock
 Press ▲ or ▼ or ENTER

2. Press **ENTER**. The current AutoLock setting will appear.
 - To leave the setting unchanged and return to the Biomed Toolbox menu, press **ENTER**.
 - To change the setting, press **YES** or **NO** to select the desired setting. Then press **ENTER**.
3. Press **YES** to confirm the change.

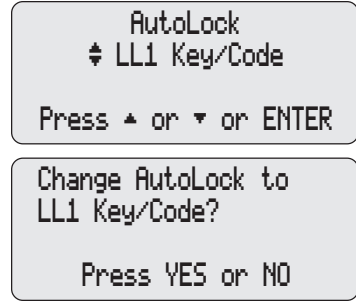

5.13 PM (Preventive Maintenance) Reminder

If your institution or health care facility establishes a maintenance program for the pump, you can use the PM Reminder to display a “Prev. Maint. Reminder” message upon power-up at a specified interval (1 to 24 months). The message will begin appearing on the date programmed and during every power up until it is reset. Use this screen to specify the interval at which the message should appear, or use it to reset the reminder.



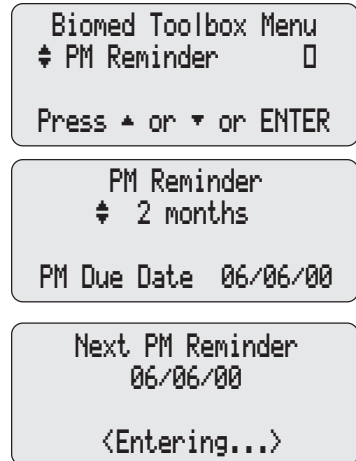



1. At the Biomed Toolbox Menu, press **YES** or **NO** until “PM Reminder” appears. If an X appears in the box, a PM Reminder is set.
2. Press **ENTER**. The PM Reminder screen will appear.
 - Press **ENTER** to reset the reminder, or
 - Press **YES** or **NO** to select the new interval. Then press **ENTER**.
3. The date corresponding to your selection (current date + number of months selected) will appear on the screen.



5.14 Custom Lock Level Code

This screen allows you to select a new Lock Level Code. Changing this code

also changes the Biomed Toolbox Code to **** Text omitted ****. It *does not* affect the Clinician Bolus Code.

1. At the Biomed Toolbox Menu, press  or  until “Custom Lock” appears. If an X appears in the box, a Custom Lock Level Code is currently set.
2. To view or change the Custom Lock Level Code, press . The current code will appear.
3. To change the Custom Lock Level Code, press  or  to select the desired code (001 to 899). Then press .
4. Press  to confirm the change.







```
Biomed Toolbox Menu
  Custom Lock
Press ▲ or ▼ or ENTER
```

```
Custom Lock Code
  ***
<Range: 1 - 899>
```

```
Change Lock Code to
  ***?
Press YES or NO
```

5.15 Custom Clinician Code

This screen allows you to select a new Clinician Bolus Code. Changing this code *does not* affect the Lock Level Code or the Biomed Toolbox Code.

1. At the Biomed Toolbox Menu, press  or  until “Custom Clinician” appears. If an X appears in the box, a Custom Clinician Code is currently set.
2. To view or change the Custom Clinician Code, press . The current code will appear.
3. To change the Custom Clinician Code, press  or  to select the desired code (001 to 999). Then press .
4. Press  to confirm the change.







```
Biomed Toolbox Menu
  Custom Clinician
Press ▲ or ▼ or ENTER
```

```
Custom Clinician Code
  ***
<Range: 1 - 999>
```

```
Change Clinician
Bolus code to ***?
Press YES or NO
```

5.16 Units Selection

Units Selection allows you to select which programming units you want to appear in the Programming Units screens. If you disable all but one set of programming units, the Programming Units will not appear. You cannot disable the programming units that is currently in use on the pump. The scroll range on the Programming Units screen will include only the selected programming units. The range in the Programming Units screen will display “Custom” if two programming units have been selected.



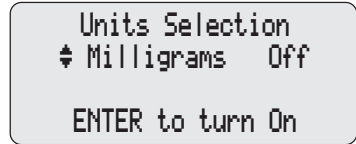
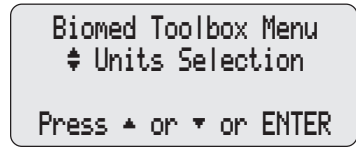



1. At the Biomed Toolbox Menu, press  or  until “Units Selection” appears.
2. To enter the Units Selection screens, press .
3. Press  or  to move through the various programming selections (Milligrams, Milliliters and Micrograms).
4. Press  to turn the Units Selection On or Off.



5.17 Units Location

Units Location allows you to select where to place Programming Units. Programming Units may be located either in the Options menu, Biomed Toolbox menu or in the pump’s programming screens.

To view or change the Units Location:

1. At the Biomed Toolbox Menu, press  or  until “Units Location” appears.
2. To change the setting, press . Press  or  to select the desired setting, then press . Select “Options” to have the Units programming be part of the Options menu, “Tool-

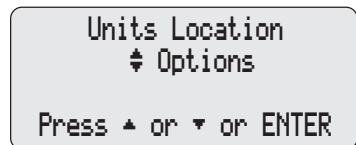
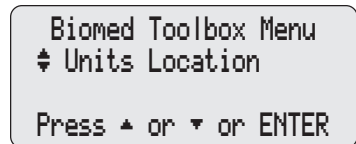

box” to have it be part of the Biomed Toolbox menu or “Program” to have it be part of the pump’s normal programming screens.







3. Press  to confirm the change.

Change Units Location
to Options?

Press YES or NO

5.18 Programming Units

This screen will appear if “Biomed Toolbox” is selected in the Units Location feature. If programming units is part of the Biomed Toolbox, you should program Units before continuing with pump programming.

1. At the Biomed Toolbox Menu, press  or  until “Programming Units” appears.
2. Press  or  to select desired units in milliliters, milligrams or micrograms. (If Programming Units does not appear, it has been programmed in Biomed Toolbox to be part of the Options menu or programming screens, or only 1 unit has been selected in Units Selection.)
3. Press .
4. Press  to confirm the change.

Biomed Toolbox Menu
◆ Programming Units

Press ▲ or ▼ or ENTER

Units
◆ Micrograms

<Range:mg, ml, mcg>

Change Units to
Milligrams?

Press YES or NO

NOTE: When you change the Units, the pump requires you to enter or verify the Continuous Rate, Demand Dose and Delivery Limit. If Units are mg or mcg, you must also enter Concentration. As this is a requirement, the pump will automatically take you to the programming screens (you will no longer be in the Biomed Toolbox).



5.19 Date Format

This screen allows you to select the date format. The date can be set to display in US Standard format (*month/day/year*) or in European Standard format (*day/month/year*).

- At the Biomed Toolbox Menu, press  or  until “Date Format” appears. Press .

```
Biomed Toolbox Menu
# Date Format

Press ▲ or ▼ or ENTER
```

- The current format will appear. To change the format, press  or . Then press .

```
Date Format
# European Standard

Press ▲ or ▼ or ENTER
```





- Press  to confirm the change.

```
Change Date Format to
European Standard?

Press YES or NO
```

5.20 Custom Main Display

This screen allows you to customize what appears on the main display. Options are Continuous Rate or Res Vol, and power source always displayed or power source only when the 9 volt battery is low.



- At the Biomed Toolbox Menu, press  or  until “Main Display” appears.
- To change the main screen display settings, press . There are two screens associated with this feature. To scroll between the two displays, press  or .

```
Biomed Toolbox Menu
# Main Display

Press ▲ or ▼ or ENTER
```

```
Main Display
# Rate 0 or Res Vol 0

Press ENTER to change
```

In the Continuous Rate or Res Vol display screen, only one box will be checked. To select the between them, press  (Res Vol is the default setting). Press  or  to view or change the power source display setting.

```
Main Display
# Always 0 or Low 9V 0

Press ENTER to change
```

In the Power Source display screen, only one box will be checked. To select the between them, press **ENTER** (Low 9V is the default setting).

NOTE: To leave a Biomed Toolbox setting unchanged, press **VIEW SILENCE**.

5.21 Auto Review

Auto review allows you to select the automatic program review feature, which would be displayed during the pump's power up sequence.

1. At the Biomed Toolbox Menu, press **YES** or **NO** until "Auto Review" appears. If an X appears in the box, Auto Review has been customized to "On".
2. To change the setting, press **ENTER**. Press **YES** or **NO** to turn Auto Review On or Off, then press **ENTER**.

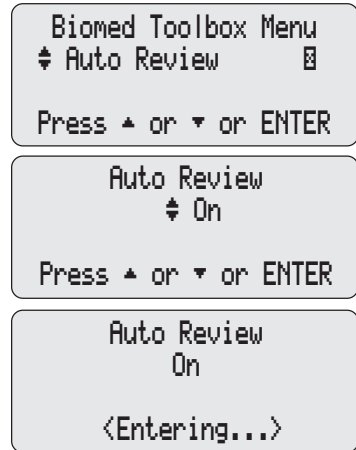





5.22 Custom Reports

This series of screens allows you to turn on those reports which can be viewed and/or changed using the **REPORTS** key. Only those reports which are enabled in the following screens will be displayed when you press **REPORTS** (see **REPORTS** key, Section 2 of this manual).

Press **YES** or **NO** to scroll through the Custom Reports Menu, then press **ENTER** to access the editing screens. Follow the instructions on the following pages for the appropriate screen. To exit the editing screens without changing a setting, press **VIEW SILENCE**. From the Custom Reports Menu, press **VIEW SILENCE** to exit back to the Biomed Toolbox Menu.

5.22.1 To access the Custom Reports Screens

1. At the Biomed Toolbox Menu, press  or  until “Custom Report” appears.
2. To enter the Custom Reports screens, press .
3. Use  or  to move through the Reports screens.



5.22.1.1 Dose Counters

The Dose Counters keep track of the number of Demand Doses given and attempted since the displayed date and time.

1. Press  to turn the Dose Counter report function on or off.

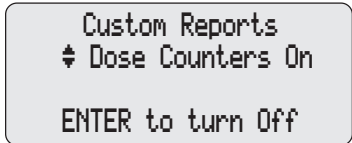

5.22.1.2 Given

Given shows the total amount of drug delivered to the patient since it was last cleared.

1. Press  to turn the Given report function on or off.

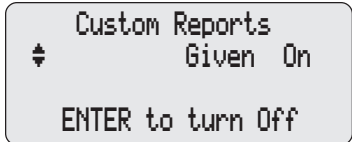

5.22.1.3 Doses Hour By Hour

Doses Hour by Hour allows you to page back through summaries for each one hour period within the last 48 hours, showing both the number of doses given and attempted.

1. Press  to turn the Doses Hr By Hr report function on or off.

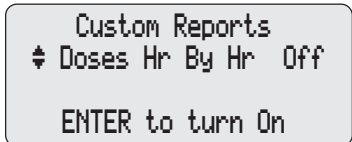

5.22.1.4 Patient Review

Patient Review allows you to review a summary of the pump’s settings and the number of doses given and attempted, Clinician Boluses deliv-

ered and total Given starting at a time and date within the last 48 hours that you specify.

1. Press **ENTER** to turn the Patient Review report function on or off.

```

Custom Reports
⚡ Patient Review On
ENTER to turn Off
  
```

5.22.1.5 Pain Scale

The Pain Scale allows the Clinician and/or patient to enter a pain scale rating.

1. Press **ENTER** to turn the Pain Scale report function on or off.

```

Custom Reports
⚡ Pain Scale On
ENTER to turn Off
  
```

5.22.1.6 Pain Scale Log

The Pain Scale Log will allow you to scroll through entries to the Pain Scale (below).

1. Press **ENTER** to turn the Pain Scale Log report function on or off.

```

Custom Reports
⚡ Pain Scale Log On
ENTER to turn Off
  
```

5.22.1.7 Delivery Log

The Delivery Log is a subset of the Event Log, and records the following types of delivery events: Demand Doses delivered, Demand Doses not delivered (due to either a Demand Dose Lockout or Delivery Limit), Clinician Boluses delivered, Pain Scale Entries and changes to the pump program or settings. The pump records the date and time of each event, and lists events in order starting from the most recent through the last 500 events.

1. Press **ENTER** to turn the Delivery Log report function on or off.

```

Custom Reports
⚡ Delivery Log Off
ENTER to turn On
  
```

5.22.1.8 Event Log

When the Event Log report is turned On, it will be displayed when you press the **REPORTS** key. The Event Log records the following types of events: hourly given totals, dose delivery, alarms, errors, power source changes, cassette changes and changes to pump programming or settings. The pump records the date and time of each event, and lists

events in order starting from the most recent through the last 500 events.

1. Press **ENTER** to turn the Event Log report function on or off.

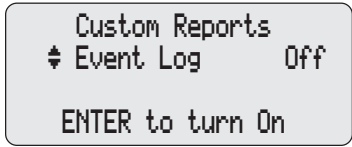

5.22.1.9 New Patient Marker

The New Patient Marker feature is configured in the Biomed Toolbox (see Section 5.16). You can program the pump to allow you to select a New Patient Marker as part of the Reports menu, as part of the pump’s power up routine when either a battery is installed or pump indicators are turned on using the keypad, or both.

The New Patient Marker allows you to access these functions in the Reports menu by pressing the **REPORTS** key.

1. Press **ENTER** to turn the New Patient Marker report function on or off.

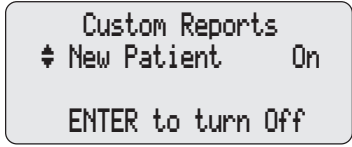

NOTE: To leave a setting unchanged, press **VIEW SILENCE**.

5.23 New Patient Marker Function

The New Patient Marker feature allows you to configure the *function* of the New Patient Marker (clearing the previous records and lockouts, clearing the pump program, or both, as described below) and the *location* of the New Patient Marker (as part of the Reports menu, as part of the pump’s power up routine when either a battery is installed or pump indicators are turned on using the keypad, or both).

Clearing the previous records and lockouts (either in the Reports menu, as part of the pump’s power up routine, or both), causes the following to occur:

- Adds an event to the Event History log
- The Pain Scale log, Delivery Log, Doses Hour by Hour and Patient Review are cleared
- Given is cleared
- Doses Attempted and Doses Given is cleared
- Any Dose Lockout time is cleared
- Any internal Delivery Limit data is cleared

Clearing the program (either in the Reports menu, as part of the pump's power up routine, or both), causes the following to occur:

- Adds an event to the Event History Log
- Previous records and lockouts are cleared (see above)
- The user may be required to program Units, Concentration, Rate, Dose and Delivery Limit, depending on the pump program parameters that are in use, and the following program values are defaulted:
 - Continuous Rate defaults to 0.
 - Demand Dose defaults to 0.
 - Demand Dose Lockout defaults to "24 Hrs 00 Min."
 - Max Doses per Hour defaults to 1.
 - Delivery Limit defaults to lowest programmable value.
 - Reservoir Volume defaults reset to previously programmed value.
 - Lock Level changes to LL0.



The New Patient Marker Function may be programmed to Reports/No Clear, Power Up/No Clear, Reports/Clear, or Power Up/Clear.

- **Option 1 Reports/No Clear** - this is the default setting. It means that if the New Patient Marker feature is turned on in the Reports menu and selected by the user, the pump will clear the previous records and lockouts and a New Patient Marker will be logged in the Event Log, **but the program will not be cleared.** The New Patient Marker feature **will not** appear as part of the pump's power up routine.
- **Option 2 Power Up/No Clear** - this means that the New Patient Marker feature will be available in both the Reports menu (in the Custom Reports menu, it must first be turned on in the Reports menu, and accessed by pressing ) and as part of the pump's power up routine. The user can clear the previous records and lockouts and a New Patient Marker will be logged in the Event Log, **but the program will not be cleared.**
- **Option 3 Reports/Clear** - this means that if the New Patient Marker feature is turned on in the Reports menu and selected, the pump will clear the previous records and lockouts and a New Patient

Marker will be logged in the Event Log, and the program will be cleared. The New Patient Marker feature **will not** appear as part of the pump’s power up routine.

- **Option 4 Power Up/Clear** - this means that the New Patient Marker feature will be available as part of the pump’s power up routine. It may be available in the Reports Menu if it has first been turned On in the Custom Reports Menu, and is then accessed by pressing **REPORTS**. The user can clear the previous records and lockouts and a New Patient Marker will be logged in the Event Log, and the program will be cleared.

5.23.1 To View or Change the New Patient Marker Function:

1. At the Biomed Toolbox Menu, press  or  until “New Patient Marker” appears.

```
Biomed Toolbox Menu
⚡ New Patient Marker



Press ▲ or ▼ or ENTER
```

2. Press **ENTER**. The current New Patient Marker Setting is shown.

```
New Patient Marker
⚡ Reports/No Clear

Press ▲ or ▼ or ENTER
```

To leave the setting unchanged and return to the Biomed Toolbox menu, press **VIEW SILENCE**.

To change the setting, press  or  to select the desired setting. Then press **ENTER**.

3. Press  to confirm the change.

```
Change Patient Marker
Configuration to
Power Up/Clear?
Press Yes or No
```

4. A confirmation screen appears telling you that the New Patient Marker configuration is being entered.

```
New Patient Marker
Configuration
Power Up/Clear
<Entering...>
```









5.24 Upstream Sensor On/Off

The Upstream Occlusion Sensor screen can be set to on or off. If this screen is set to on, and an upstream occlusion (between pump and fluid container) is detected, an alarm will sound, delivery will stop, and the display will show “Upstream Occlusion.”

The Upstream Occlusion Sensor will also detect a partial occlusion. If the partial occlusion or restriction in flow is sufficient to activate the sensor, and then clears, the pump will show a brief screen message “Upstream Occlusion” and the pump will beep to coincide with the screen message. An insistent alarm will not occur if the occlusion clears itself. Continued restriction in flow causing repeated “Upstream Occlusion” messages that subsequently clear themselves can lead to under-delivery of medication, which could be up to 10% of the set delivery rate. The Upstream Occlusion events will be recorded in the pump event history as “Upstream Occlusion - detected” and “Upstream Occlusion - Ended” when the occlusion is cleared.

WARNING: When the Upstream Occlusion Sensor is turned Off, the pump will not detect occlusions upstream (between pump and fluid container). It is recommended that you periodically inspect the fluid path for kinks, a closed clamp, or other upstream obstructions. Upstream occlusions may result in under- or nondelivery of medications. If undetected, the occlusions could lead to serious patient injury or death.

- At the Biomed Toolbox Menu, press  or  until “Upstream Sensor” appears. If an X appears in the box, the upstream sensor is currently On.
- To change the setting, press . Press  or  to select the desired setting, then press .
- Press  to confirm the change.

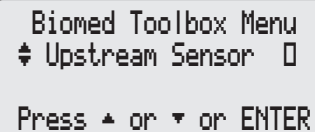

Biomed Toolbox Menu
 ⬇ Upstream Sensor 0
 Press ▲ or ▼ or ENTER



Upstream Sensor
 ⬇ On
 Press ▲ or ▼ or ENTER

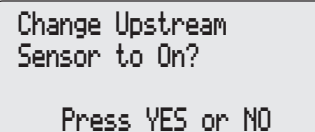



Change Upstream
 Sensor to On?
 Press YES or NO





5.25 Air Detector Requirement

The Air Detector screen can be set to “Required” or “Not Required.” If this screen is set to “Required,” *an Air Detector must be installed and active in order to start the pump*; however, the pump may be programmed without an Air Detector.

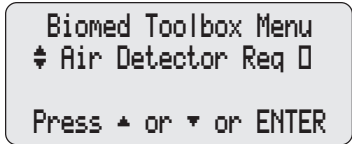
WARNING: When the Air Detector is not installed, or is installed but turned Off, the pump will not detect air in the fluid path. It is recommended that you periodically inspect the fluid path and remove any air to prevent air embolism. Air embolism could result in serious patient injury or death.

1. At the Biomed Toolbox Menu, press  or  until “Air Detector Req” appears. If an X appears in the box, the Air Detector is currently required.



2. To change the setting, press . Press  or  to select the desired setting, then press .

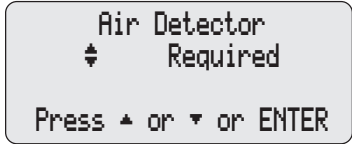

3. Press  to confirm the change.

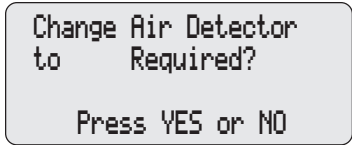

Section 6: Reference & Troubleshooting

6.1 Troubleshooting

A continuous two-tone alarm is sounding; the amber light is lit or flashing.

Delivery has stopped. Read the message on the display and refer to the list of messages beginning on the next page. If the display is blank or contains random characters, the 9 volt battery may be depleted; install a new battery.

The pump is sounding 2 beeps every two seconds; the amber light is flashing.

Look at the message on the display and refer to the list of messages beginning on the next page.

Three beeps or a two-tone alarm sounds every 5 minutes.

This is a reminder that the pump is stopped.

After installing a battery, no screen appears and no beep sounds

The battery may have been installed backwards. Review the procedure for installing a battery. Be sure to match the polarity (+ and –) markings on the side of the pump with the markings on the battery. If there is still no power, the battery may be completely depleted.

Lock Level Code or Clinician Bolus Code does not work, or I forgot the custom code

If the Lock Level or Clinician Bolus Code does not work, it may have been customized. (<Custom> will appear on the code screen.) If necessary, contact Smiths Medical MD's Customer Service Department for instructions on reverting to the standard code. If you are trying to use a custom code, it is possible that the code has been reset.

Printing Problems

Make sure

- the Interface Cable is connected properly to the Data In/Out jack
- printer switches are set properly (See *Instruction for Use* supplied with Interface Cable)
- the printer is plugged in and on-line
- paper is loaded with the correct side facing out, and paper is not jammed

Refer also to the printer manual supplied with the printer.

An Air In Line alarm keeps occurring even though the Air Detector was turned off







Any time you power up the pump in Lock Level 0, the Air Detector will automatically turn on. In other words, the pump will automatically change the Air Detector Option setting from “Turned Off” to “Turned On.” (This does not occur in Lock Level 1 or 2.) If you do not want to use the Air Detector, you will need to change the Air Detector Option setting back to “Turned off” after the pump powers up. If the Lock Level is LL1 or LL2 when the pump powers up, the Air Detector Option setting will remain “Turned Off.”

Unable to select a specific concentration

The concentration may be turned off in the Biomed Toolbox. If appropriate, turn the

concentration on (Section 5). Or, the concentration may not be programmable (see scroll range tables, this section).

6.2 Alarms and Messages, Alphabetical List

Messages and Alarms	Description / Corrective Action
9 volt Battery Depleted / Install good battery	<p>The battery power is too low to operate the pump. The pump is now stopped. Press  to silence the alarm.</p> <ul style="list-style-type: none"> • Install a new 9 volt battery. A good battery must always be installed even when an external source of power is connected. • Press  to restart the pump. <p>NOTE: This message may appear when you install a new battery while an external source of power is connected. Remove and reinstall the battery to cancel this message, then restart the pump if necessary.</p>
9 volt Battery Low	<p>The 9 volt battery is low but the pump is still operable. Press  to silence the alarm.</p> <ul style="list-style-type: none"> • Change the 9 volt battery soon. <p>NOTE: This message may appear when you install a new battery while an external source of power is connected. Remove and reinstall the battery to cancel this message.</p>
9 volt Battery Removed / Install good battery	<p>With an external power source attached, the 9 volt battery was removed. The pump is still running. Press  to silence the alarm. Install a new 9 volt battery within 3 minutes to keep the pump running; after 3 minutes, the pump will stop.</p>
9 volt Battery Removed / Pump will not run	<p>With an external power source attached, the 9 volt battery was removed. The pump is stopped. Press  to silence the alarm, then install a new battery.</p>
AC Adapter Disconnected	<p>The AC Adapter was disconnected and the pump is being powered by the 9 volt battery. Press  to silence the alarm. If desired, reconnect the AC Adapter.</p>

Messages and Alarms

Description / Corrective Action

AC Adapter Unpowered /
Check power source

The AC Adapter is not receiving power from the wall outlet. The 9 volt battery is powering the pump. Press  to silence the alarm. Make sure the AC Adapter is properly plugged into the wall outlet and the wall outlet is supplying power. If the alarm persists, the AC Adapter may be faulty and may need to be replaced.



Air Detector Port Cover
Removed / Install Cover

The cover for the Air Detector port on the side of the pump must be properly attached for the pump to operate. Remove all power. Make sure the cover is installed properly, then resume operation.

Air Detector Fault /
Pump will not run

The Air Detector is faulty. Press  to silence the alarm. Close the tubing clamp, remove the pump from use, and replace the Air Detector.

Air Detector Removed?

The Air Detector has been removed. If this is acceptable, press . If the Air Detector *should* be installed or has not actually been removed, press . Then have an Air Detector installed properly. If an Air Detector is attached and the alarm persists, have the Air Detector serviced.







Air Detector Required /
Pump will not run



This message indicates that an Air Detector is required to start the pump (i.e. the Air Detector setting in the Biomed Toolbox is “Required”). If necessary, press  to silence the alarm, then have an Air Detector installed.



Air in line detected /
Pump will not run

The Air Detector has detected air in the fluid path; the fluid path may contain air bubbles, or the tubing may not be threaded through the Air Detector. Press  to silence the alarm, then:









- Make sure the tubing is threaded properly.
- If the fluid path contains air bubbles, close the clamps and disconnect the fluid path from the patient. Then follow the instructions for removing air by priming, described in Section 2). Restart the pump.

Messages and Alarms	Description / Corrective Action
All concentrations cannot be turned off	At least one concentration must be turned on when customizing concentrations. Press  , then enable a concentration.
Cable Removed	The cable was detached from the Data In/Out jack. Reinsert the cable or press  to silence the alarm.
Cassette Damaged / Free flow may occur / Clamp Tubing / Change Cassette	The pump detects the cassette is damaged. Close the tubing clamp and inspect the cassette for damage. Replace it if necessary.
Cassette not attached / Pump will not run	The pump will not start without a cassette attached. Make sure a cassette is attached properly. Then start the pump.
Cassette Unlocked	The current delivery mode requires the cassette to be locked onto the pump. If an alarm is sounding, press  to silence the alarm. Lock the cassette. If required, restart the pump.
Cassette Unlatched / Close clamp to prevent free flow	This message appears as a reminder to close the tubing clamp when the cassette is unlatched from the pump.
Change (setting) to (X)?	<p>The message is asking for confirmation of the value you entered. Check the value. If it is correct, press . If it is incorrect, press  and choose a correct value.</p> <p>If this message appears when you try to use  to go to the next screen, you may have changed the Units or Concentrations. The pump is requiring you to verify the current setting on this screen or to program a new setting.</p>
Check for empty tubing or reservoir	The tubing beneath the pump may not contain fluid, or the fluid container may be empty. Check whether the fluid container is empty; or clamp the tubing, remove the cassette, and check for air in the tubing. If the alarm persists after trying the above, it means the pump's pressure sensor is faulty. Remove the pump from service and contact Customer Service.

Messages and Alarms	Description / Corrective Action
Clinician Bolus not available during Demand Dose	A Clinician Bolus may not be started while a Demand Dose is being delivered. Wait until the Demand Dose finishes, then start the Clinician Bolus if appropriate.
Clock Battery needs service soon	The clock battery must be replaced soon. When feasible, remove the pump from use and return it for replacement of the clock battery.
Clock Battery is low / Service immediately	The clock battery is low and must be serviced. Close the tubing clamp and remove the pump from use. Contact Customer Service for replacement of the clock battery.
Communication failed	The pump is on the receiving end of Communications, and Communications has failed. Press  to silence the alarm. Wait for the person initiating Communications to call you back. Make sure your modem is hung up.
Current Concentration cannot be turned off	The currently programmed Concentration cannot be disabled. Exit the Biomed Toolbox and change to a different Concentration. Then return to the Biomed Toolbox and turn off this concentration.
Delivery Limit reached / Current delivery at KVO (.1 ml/hr)	The programmed Delivery Limit has been reached, and the pump is delivering fluid at the KVO rate. This alarm occurs when the Continuous Rate was programmed originally to greater than 0 ml/hr, and either a Demand Dose or the Continuous Rate has caused the Delivery Limit to be exceeded. This alarm silences itself in a few seconds, or can be immediately silenced by pressing  .
Delivery Limit reached / No rate, delivery at 0.0 ml/hr	The programmed Delivery Limit has been reached, and the pump is not delivering fluid. This alarm occurs when the Continuous Rate was programmed originally to 0 ml/hr, and a Demand Dose has caused the Delivery Limit to be exceeded. This alarm silences itself in a few seconds, or can be immediately silenced by pressing  .

Messages and Alarms	Description / Corrective Action
Delivery Too Slow / External power source must be connected	The 9 volt battery does not provide sufficient power to support the programmed delivery rate. Connect an external source of power. Or, if appropriate, acknowledge the message and allow delivery to proceed at the lower rate by pressing  .
Dose Not Delivered / Dose not available when pump is stopped	The pump must be running in order to start a Demand Dose. First start the pump, then request a Demand Dose.
Dose Not Delivered / Dose Locked Out	The Lockout Time is preventing the Demand Dose from being delivered. Wait until the lockout time elapses before requesting a Demand Dose.
Dose Not Delivered / No Dose programmed	The Demand Dose amount is set to 0. Therefore, a Demand Dose cannot be delivered.
Error Detected / E (code)	A pump fault has occurred. Close the tubing clamp and remove the pump from use. Contact Customer Service to return the pump for service.
External Power Source Faulty / Change Power Source	The power pack or the AC Adapter is faulty. Ensure the cords and cables are properly attached. If this does not correct the problem, replace the power source.
Finished / Please remove cable	Printing has finished. Remove the cable from the Data In/Out jack to continue.
High Pressure	The pump has detected high pressure, which may be resulting from a downstream blockage, kink in the fluid path, or a closed tubing clamp. Remove the obstruction to resume operation. Or, press  to stop the pump and silence the alarm for 2 minutes, then remove the obstruction and restart the pump.
High Volume Admin set not supported in this version of PCA / Remove admin set	The CADD-Prizm™ High Volume Administration Set cannot be used with the PCA delivery mode. You must remove the administration set to continue.



Messages and Alarms	Description / Corrective Action
Insufficient External Power Check Power Source	The AC Adapter is not receiving power or the power pack is completely depleted. Ensure the cords and cables are properly attached. Or, begin recharging the power pack.
Key Stuck / Release key or remove power to stop pump	A key may be pressed down. Make sure there is nothing pressing on any of the keys. If the alarm persists, close the tubing clamp and remove the pump from use. Contact Customer Service to return the pump for service.
Motor is temporarily disabled / Remove power and restart pump	The pumping mechanism temporarily stopped. Remove the external power source (if applicable). Then remove and reinsert the 9 volt battery and reconnect the external power source if desired. Restart the pump.
Motor service due	The pump's motor requires service. Remove the pump from use at the next cassette change and contact Customer Service to return the pump for service.
No Rate or Dose Programmed / Pump will not run	The pump will not start if no rate or doses have been programmed. Follow the instructions in Section 2 for programming the pump.
Non-Epidural cassette attached / Remove Cassette to continue	 was pressed at the screen asking if an epidural cassette was attached. Remove and replace the cassette (with an epidural cassette) to continue.
Possible hardware problem / Service pump	There may be a hardware problem with the Air Detector. Have the Air Detector replaced.
Power Pack Depleted / Change Power Source	The power pack is depleted and unable to support pump operation. The 9 volt battery is supplying power. Recharge the power pack with the AC Adapter.
Power Pack Disconnected	The power pack is disconnected from the pump. Reconnect the power pack, attach an AC Adapter, or allow the pump to run on the 9 volt battery power.

Messages and Alarms	Description / Corrective Action
Prev. Maint. Reminder (date)	Your institution may have established a maintenance program for the pump, and the pump is due for preventive maintenance. Refer to your institution's policy.
Print Failure / Check printer & cable	Printing has stopped. The paper may be out or jammed, the printer may have lost power, or the printer may be off-line. Press  to silence the alarm and refer to the printer manual to correct the problem. Then remove and reattach the cable and repeat printing.
Printing Stopped / Print Again?	During printing,  was pressed, signalling printing to stop. To start over, press  . To exit printing, press  .
Reservoir Volume is zero	The Reservoir Volume has reached 0.0 ml. Press  to silence the alarm. Install a new fluid container, if appropriate.
Reservoir Volume Low	The Reservoir Volume value is low, indicating that the level of fluid in the fluid container is low. Prepare to install a new fluid container, if appropriate.
Res Vol Alert / (X) ml remaining / VIEW to continue	The programmed Res Vol alarm trip point has been reached. Press  to silence the alarm. Prepare to install a new fluid container, if appropriate.
Reset Reservoir Volume to (X) ml?	If you wish to reset the Reservoir Volume to the originally programmed value, press  . To leave the Reservoir Volume value unchanged, press  .
To continue, unlatch and remove the Admin set or reservoir / Then re-attach	The cassette was not completely removed from the pump before it was reattached and, therefore, the pump's sensors are not able to detect the cassette type. Remove the cassette and reattach it, then verify the cassette type in the pump's display. If this alarm persists, remove the pump from use and contact Customer Service to return the pump for service.

Messages and Alarms

Description / Corrective Action

Upstream Occlusion

Fluid is not flowing from the fluid container to the pump, which may be resulting from a kink, a closed clamp, or air bubble in the tubing between the fluid container and pump. Remove the obstruction to resume operation. Or, press  to stop the pump and silence the alarm for 2 minutes, then remove the obstruction and press  to restart the pump.

Wrong Cassette

The pump detects the cassette is damaged, attached improperly, or incompatible with the pump. Close the tubing clamp. Make sure the cassette is attached properly. Then open the clamp and restart the pump. If the alarm persists, you may need to replace the cassette.

6.3 Cleaning the Pump and Accessories

CAUTION:

- Do not immerse the pump in cleaning fluid or water. Do not allow solution to soak into the pump, accumulate on the keypad, or enter the battery compartment, Data In/Out jack, Power jack or Air Detector port area. Moisture buildup inside the pump may damage the pump.
 - Do not clean the pump with acetone, other plastic solvents, or abrasive cleaners, as damage to the pump may occur.
-

Use any of the following solutions to clean the pump and accessories:

- Soap solution
 - Benzalkonium Chloride concentrate (0.13%)
 - Glutaral Concentrate, USP (2%)
 - 10 percent solution of household bleach (one part household bleach to nine parts water)
 - Alcohol, USP (93%)
 - Isopropyl Alcohol, USP (99%)
1. Dampen a soft, lint-free cloth with cleaning solution. Apply the solution to exterior surface of the pump or accessory. *Do not allow the solution to soak into the pump or accessory.*
 2. Wipe the entire surface dry with another soft, lint-free cloth. Allow the pump to dry completely before use.

6.3.1 Cleaning the Battery Contacts

Routinely clean the battery contacts, possibly as part of the preventative maintenance cycle, to remove buildup of foreign material on the contacts.

Use the following to clean the battery contacts:

- Cotton swab wetted with Isopropyl Alcohol (70% minimum)

NOTE: Do not use an alcohol formulation that contains components other than alcohol and water.

OR

- Pre-moistened alcohol swab
1. Using a swab wetted with alcohol, rub the entire battery contact for a minimum of ten back and forth cycles (twenty total wipes over the contact).
 2. Using a clean surface of the swab, repeat the process for the second battery contact.
 3. Using a clean swab wetted with alcohol, rub each battery contact again, a minimum of four back and forth cycles (eight total wipes over the contact).
 4. Allow the contacts to dry completely before use.

6.4 Exposure to Radiation or Magnetic Resonance Imaging (MRI)

CAUTION:

- Do not expose the pump to therapeutic levels of ionizing radiation as permanent damage to the pump's electronic circuitry may occur. The best procedure to follow is to remove the pump from the patient during therapeutic radiation sessions. If the pump must remain in the vicinity during a therapy session, it should be shielded, and its ability to function properly should be confirmed following treatment.
 - Do not expose the pump directly to ultrasound, as permanent damage to the pump's electronic circuitry may occur.
 - Do not use the pump in the vicinity of magnetic resonance imaging (MRI) equipment as magnetic fields may adversely affect the operation of the pump. Remove the pump from the patient during MRI procedures and keep it at a safe distance from magnetic energy.
 - Use of this pump on patients monitored by electronic equipment may cause artifactual interference. As with all electronic equipment, electrical artifacts which affect the performance of other equipment, such as ECG monitors, can occur. The user should check the correct function of the equipment prior to use.
-

6.5 Continuous Rate Scroll Ranges

Units	Starting Value	Increment	Maximum
Milliliters	0.10	0.10	30.00
Milligrams & Micrograms	10% of concentration	Mg only: Values between 0.01 and 0.5: Mcg only: Values between 0.1 and 0.5: Values between 0.5 and 100: Values between 100 and 1000: Values greater than 1000:	0.01 0.1 0.1 1.0 10.0
			Concentration × 30

6.6 Demand Dose, Clinician Bolus Scroll Range: Milliliters

Milliliters	
increment	max.
0.05	20

6.7 Demand Dose, Clinician Bolus Scroll Range: Milligrams

Concentration mg/ml	Milligrams	
	increment	max.
0.1	0.01	2
0.2	0.02	4
0.3	0.03	6
0.4	0.04	8
0.5	0.05	10
1	0.05	20
2	0.10	40
3	0.15	60
4	0.20	80
5	0.25	100
6	0.30	120
7	0.35	140
8	0.40	160
9	0.45	180
10	0.50	200
11	0.55	220
12	0.60	240
13	0.65	260
14	0.70	280
15	0.75	300
20	1.00	400
25	1.25	500
30	1.50	600
35	1.75	700
40	2.00	800
45	2.25	900
50	2.50	1000
55	2.75	1100
60	3.00	1200
65	3.25	1300
70	3.50	1400
75	3.75	1500
80	4.00	1600
85	4.25	1700
90	4.50	1800
95	4.75	1900
100	5.00	2000

6.8 Demand Dose, Clinician Bolus Scroll Range: Micrograms

Concentration mcg/ml	Micrograms	
	increment	max.
1	0.05	20
2	0.10	40
3	0.15	60
4	0.20	80
5	0.25	100
6	0.30	120
7	0.35	140
8	0.40	160
9	0.45	180
10	0.50	200
11	0.55	220
12	0.60	240
13	0.65	260
14	0.70	280
15	0.75	300
20	1.00	400
25	1.25	500
30	1.50	600
35	1.75	700
40	2.00	800
45	2.25	900
50	2.50	1000
55	2.75	1100
60	3.00	1200
65	3.25	1300
70	3.50	1400
75	3.75	1500
80	4.00	1600
85	4.25	1700
90	4.50	1800
95	4.75	1900
100	5.00	2000
200	10.00	4000
300	15.00	6000
400	20.00	8000
500	25.00	10000

6.9 Military Time Conversion Chart

12-Hour Time	Military Time
12:00 AM (midnight)	00:00
1:00 AM	01:00
2:00 AM	02:00
3:00 AM	03:00
4:00 AM	04:00
5:00 AM	05:00
6:00 AM	06:00
7:00 AM	07:00
8:00 AM	08:00
9:00 AM	09:00
10:00 AM	10:00
11:00 AM	11:00
12:00 PM (noon)	12:00
1:00 PM	13:00
2:00 PM	14:00
3:00 PM	15:00
4:00 PM	16:00
5:00 PM	17:00
6:00 PM	18:00
7:00 PM	19:00
8:00 PM	20:00
9:00 PM	21:00
10:00 PM	22:00
11:00 PM	23:00

6.10 Technical Description

6.10.1 Standards Used in Development of the Pump

The following standards were used in whole or part in the development of the pump.

IEC 1000-4-2, 8 kV contact discharge, 15 kV air discharge.

IEC 1000-4-3, 26 MHz to 1 GHz, 10 V/m, 1 kHz – 80% AM modulation.

IEC 1000-4-4, AC Fast Transients, at ±500 volts, ±1000 volts, and ±2000 volts.

IEC 1000-4-5, AC Surges, 1 kV differential mode, 2 kV common mode.

IEC 1000-4-8, AC Magnetic field, at 400 Amperes/meter.

IEC 1000-4-11, AC Steady State, Dropout & Slow Sags/Surge.

For CISPR 11 and CISPR 14 tests, the pump was fitted with an administration set with its inlet connected to a 250 ml bag and its outlet routed back to the bag forming a closed loop system. A total of six feet of tubing was used to form the closed loop.

6.10.2 Specifications (Nominal)

6.10.2.1 General Pump Specifications

Resolution	Medication Cassette Reservoir or CADD™ Administration Set, 0.050 ml per pump stroke nominal
Size	4.4 cm × 10.4 cm × 14.1 cm [1.7 in. × 4.1 in. × 5.6 in.] excluding cassette or other accessories
Weight	568 g [20 oz.] including 9 volt battery and empty 100 ml Medication Cassette Reservoir, excluding other accessories
Classification	CF <input checked="" type="checkbox"/> , Class II <input type="checkbox"/>
Moisture Protection	Splashproof (IPX4)
Pump Alarms	Low battery power; depleted battery power; external power source low, faulty, depleted; pump stopped; pump fault; low reservoir volume; high delivery

pressure; air in line; Air Detector faulty or detached (only with the use of the optional Air Detector); Air Detector Port Cover detached; delivery too slow; key stuck; cassette detached or unlocked; print failure, epidural cassette not used.

Maximum Infusion

Pressure 27.0 psi [1.86 bar]

Maximum Time to

Occlusion Alarm CADD™ Administration Set: 3.0 hours

Bolus Volume at

Occlusion Alarm

Pressure 0.050 ml resolution administration sets/Medication
Cassette Reservoirs: <0.25 ml
0.100 ml resolution administration sets: <2.0 ml

Power Sources 9 volt alkaline or lithium battery such as DURACELL® Alkaline MN 1604 or ULTRALIFE® Lithium U9VL; CADD™ External Power Source (EPS) Power Pack re-order number 21-3801; AC Adapter.

The expected life of a 9 volt battery is 12 hours at 100 ml/hour, or approximately 5 days at 10 ml/day (nominal). This estimate is based on laboratory tests conducted at room temperature using a new battery. Actual battery life will vary depending on the brand of battery, shelf life, temperature conditions, delivery rate, and frequency of screen display, backlighting and printing. It is recommended that a new 9 volt battery be kept available for replacement if necessary.

An internal battery powers the clock. When it is depleted, it cannot reliably maintain the clock time. This battery must be replaced by the manufacturer. The internal battery has an expected life of 5 years.

System Operating

Temperature +2°C to 40°C (36°F to 104°F)

System Storage

Temperature -20°C to 60°C (-4°F to 140°F)

Power Pack Charging

Temperature +10°C to 35°C (50°F to 95°F)

System Delivery

Accuracy $\pm 6\%$ (nominal). At low infusion rates, this accuracy may not be achieved for short periods. During the total infusion time, the accuracy averages out (see Accuracy Curves, this section).

WARNING: Ensure that the $\pm 6\%$ System Delivery Accuracy specification is taken into account when programming the pump and/or filling the Medication Cassette Reservoir. Failure to do so may result in medication in the reservoir becoming depleted sooner than expected. If the pump is being used to deliver critical or life sustaining medication, the interruption in the delivery of medication could result in patient injury or death.

System Definition System is defined as a CADD-Prizm[®] pump with an attached Medication Cassette Reservoir and CADD[™] Extension Set, or an attached CADD[™] Administration Set. OR a CADD-Prizm[®] pump with an attached Medication Cassette Reservoir with flow stop feature and CADD[™] Extension Set, or a CADD[™] Administration Set with flow stop feature (reorder numbers start with 21-73xx).

High Pressure Alarm 18 ± 9 psi [1.24 ± 0.62 bar]

Air Detector Alarm Single bubble greater than 0.100 ml

Bolus Accuracy at Set
Value of 0.1 ml $\pm 6\%$

Bolus Accuracy at Set
Value of 6.0 ml $\pm 6\%$

Maximum Volume Infused
Under Single-Fault
Conditions CADD[™] Administration Set:
0.2 ml

Delivery Rate during
priming Approx. 347 ml/hr

Alarm disabled during
priming High Pressure

6.10.2.2 Delivery Specifications

Reservoir Volume	1 to 9999 or Not In Use; programmable in 1 ml increments, displayed in 0.1 ml increments. Default: 1 ml
Units*	Milliliters (ml), milligrams (mg), micrograms (mcg). Default: milligrams
Concentration	Mg/ml: 0.1 to 0.5 mg/ml in increments of 0.1 1 to 15 mg/ml in increments of 1 mg/ml 20 to 100 mg/ml in increments of 5 mg/ml Default: 100 mg/ml Mcg/ml: 1 to 15 mcg/ml in increments of 1 mcg/ml 15 to 95 mcg/ml in increments of 5 mcg/ml 100 to 500 mcg/ml in increments of 100 mcg/ml. Default: 500 mcg/ml
Continuous Rate	0 to 30 ml/hr (or the mg or mcg equivalent). Default: 0 mg/hr
Demand Dose	0 to 20.0 ml Delivery rate (Continuous Rate + Demand Dose): programmable from 40 to 125 ml/hr. Default: 0 ml
Demand Dose Lockout ...	5 minutes to 24 hours in the following increments: 1 minute for values between 5 and 20 minutes 5 minutes between 20 minutes and 24 hours Default: 5 min
Max Doses per Hour	1 to 12. Default: 1
Set Delivery Limit	0.5 ml to 1000 ml (or the mg or mcg equivalent), or “No Limit”: 0.01 from 0.01 to 0.1 0.1 from 0.1 to 100 1.0 from 100 to 1000 10.0 from 1000 to 10000 100.0 from 10000 to 100000 1000.0 from 100000 and up Default: 0.5 ml or mcg or mg equivalent
Given	0 to 99999.99 in 0.01 unit increments.
Clinician Bolus	0.1 ml to 20.00 ml (or mg or mcg equivalent) Delivery rate (Continuous Rate + Clinician Bolus): 125 ml/hr nominal

* If programmed to be part of pump programming screens in Biomed Toolbox.

6.10.2.3 Options Specifications

- Lock Level LL0, LL1, LL2. Default: LL2
- Epidural Mode On or Off. Default: Off
- Units* Milliliters (ml), milligrams (mg), micrograms (mcg).
Default: milligrams
- Time 00:00 to 23:59
- Air Detector Turned On or Turned Off. Default: Turned On.

6.10.2.4 Biomed Toolbox Specifications

- Custom Concentrations ... All individual mg or mcg concentration settings may be enabled or disabled (at least one concentration must be enabled). Default: All On
- Dosing Limit Delivery Limit, Max Doses Per Hour or Neither.
Default: Neither
- Delivery Limit** 1 to 12 hours in increments of 1 hour.
Default: 4 Hours
- Program Limits Maximum limits (in mg, mcg and ml) can be programmed for Demand Dose, Continuous Rate and Clinician Bolus. Default: Maximum values
- Maximum Delivery
Rate 40 to 125 ml/hr in increments of 1 ml/hr. Default: 125 ml/hr
- Key Beeps On or Off. Default: On
- Res Vol Trip Point 1 to 999 ml in increments of 1 ml, or “Standard.”
Default: Standard
- Res Vol Empty Alarm Single or Insistent. Default: Single
- Pump Stopped Alarm Beep or Two-Tone. Default: Beep
- Titration Limit 1 to 300 percent in increments of 1 percent, or “No Titration” or “No Limit.” Default: No Titration
- AutoLock Not In Use, LL1 Key/Code, LL2 Key/Code, LL1 No Key or LL2 No Key. Default: Not In Use

* If programmed to be part of Options settings in the Biomed Toolbox.

** If chosen in Dosing Limit

PM (Preventive Maintenance) Reminder	1 to 24 months in 1 month increments, or “Not In Use.” Default: Not In Use
Custom Lock Level Code	001 to 899 (excluding preset code) in increments of 1. Default: ** Text omitted **
Custom Clinician Code	001 to 999 (excluding preset code) in increments of 1. Default: ** Text omitted **
Units Selection	All individual unit settings may be enabled or disabled (at least one unit must be enabled). Default: All On
Units Location	Options, Biomed Toolbox or Program. Default: Programming screens
Programming Units*	Milliliters (ml), milligrams (mg), micrograms (mcg). Default: milligrams
Date Format	US Standard (mm/dd/yy) or European Standard (dd/mm/yy). Default: U.S. Standard
Custom Main Display	Display: Res Vol or Continuous Rate Power Source Always or Low 9 volt battery only Default: Res Vol and Low 9V
Auto Review	On or Off. Default: On
Custom Reports	Turned On (displayed) or Turned Off (not displayed) when  key is pressed: <ul style="list-style-type: none"> • Dose Counters (0 to 999 Given and/or Attempted). Default: On • Given. Default: On • Doses Hour By Hour (up to 48 hours in increments of 1 hour). Default: Off • Patient Review. Default: Off • Pain Scale (subjective pain scale rating of 0 to 10 in increments of 1). Default: Off • Pain Scale Log (0 to 500 entries). Default: Off • Delivery Log (0 to 500 events). Default: Off • Event Log (0 to 500 events). Default: Off • New Patient Marker. Default: On

* If programmed to be part of Biomed Toolbox settings in the Biomed Toolbox.

New Patient Marker Reports/No Clear
Power Up/No Clear
Reports/Clear
Power Up/Clear
Default: Reports/No Clear

Upstream Occlusion
Sensor On or Off. Default: On

Air Detector Required Required or Not Required. Default: Required

6.10.3 Printed Reports



An Interface cable is available for printing or communications. Five types of reports are available: the Rx Settings Report lists the pump's current program; the Event Log Report includes Rx settings and the event log through the last 500 events; the Patient History Report lists current pump settings, amount of medication delivered, and hourly dose summaries for the time period you specify (for the past 48 hours or to the last New Patient Marker or Change in Units, Time, or Date; beyond any of these events, the report will show zeroes); the Pain Scale Log Report includes the Rx Settings Report and all Pain Scale entries in the Event Log, up to the most recent New Patient Marker; the Delivery Log report is a subset of the Event Log Report, and includes the Rx Settings Report and all delivery related entries in the Event Log, up to the most recent New Patient Marker.

For additional information on printing or communications, see the instructions for use provided with the interface cable.

6.10.4 Screen Maps

Programming Screens





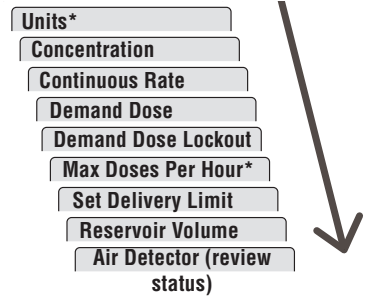

From Main Screen, press .

Press  or  to move through screens.



Options Menu Screens

With the pump stopped, from any screen, press .

Press , ,  or  to move through menu; press  to enter editing screens; press  to exit editing screens without making changes.

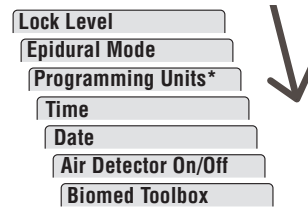





From menu, press  to exit Options.

* If programmed to appear here in the Biomed Toolbox.

Biomed Toolbox Menu Screens

From Options menu item Biomed Toolbox, press .

Press  or  to move through menu; press  to enter editing screens. Press  to exit editing screens without making changes.

From menu, press  to return to Options menu.

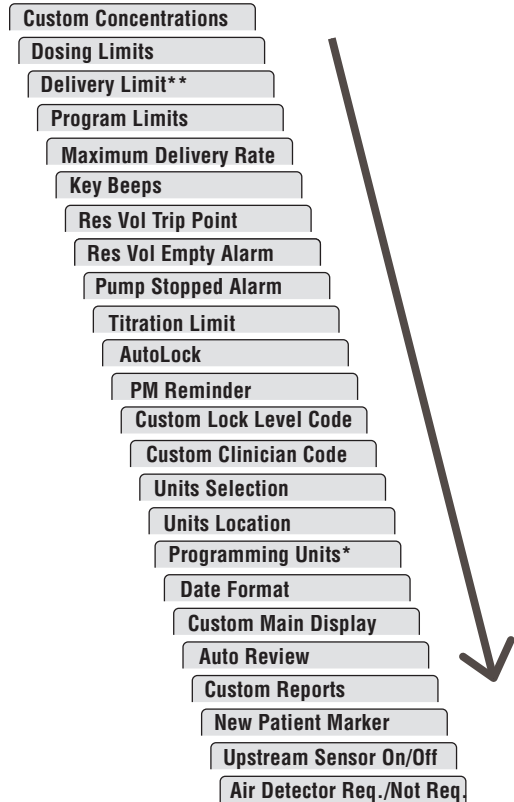

Custom Reports Menu Screens

From Custom Reports screen in Biomed Toolbox, press .

Press  or  to move through menu.

Press  to return to Biomed Toolbox menu.

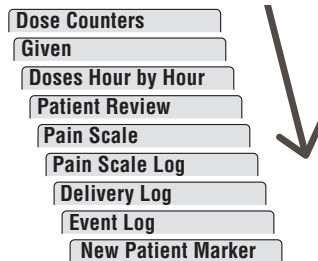

* If programmed to appear here in the Biomed Toolbox.

** If chosen to appear in Delivery Limits

6.11 Accuracy Test Results

The following graphs are designed to show flow accuracy of the infusion system plotted against given time periods.

Flow rate immediately following startup

Time Interval: 0.5 min
 Total Time: 120 min
 Programmed Rate: 24.0000 ml/hr
 Cassette used: CADD™ Administration Set

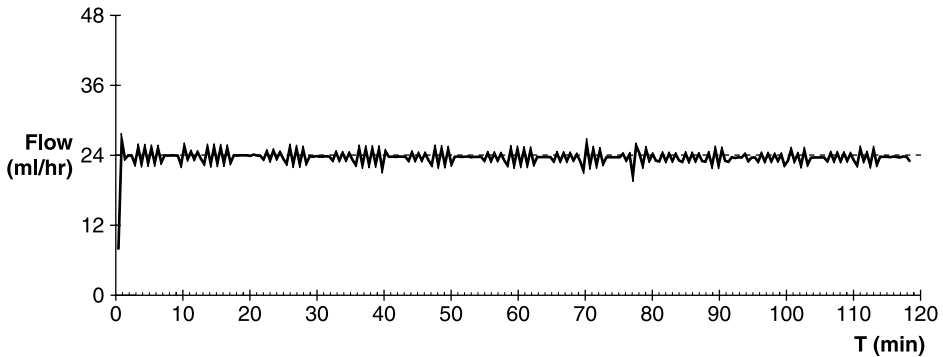

Short term flow rate error

Programmed Rate: 24.0000 ml/hr
 Average Flow Rate: 23.7227 ml/hr
 Mean Flow Error: -1.16%
 Cassette used: CADD™ Administration Set

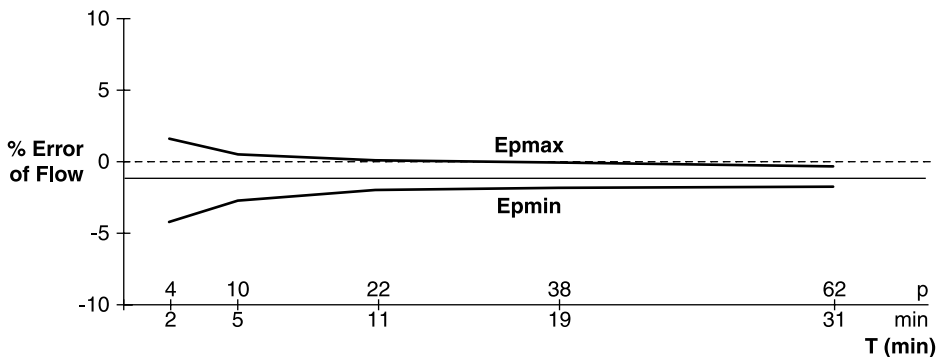

Flow rate immediately following startup

Time Interval: 15 min
 Total Time: 1500 min
 Programmed Rate: 0.1 ml/hr
 Cassette Used: CADD™ Administration Set

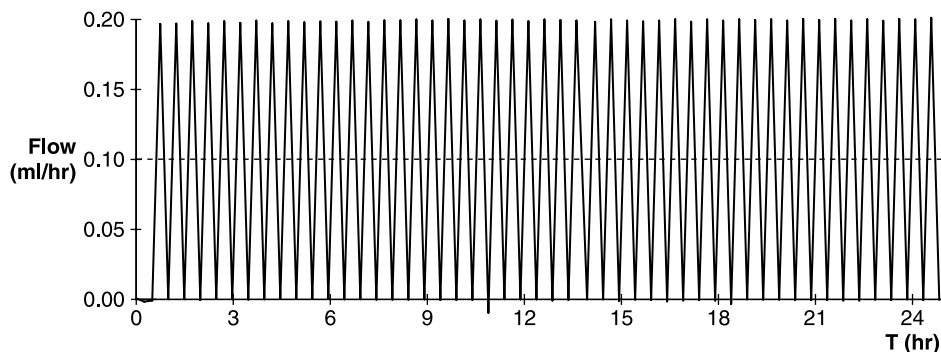

Short term flow rate error

Programmed Rate: 0.1 ml/hr
 Average Flow Rate: 0.0989 ml/hr
 Mean Flow Error: -1.05 %
 Cassette Used: CADD™ Administration Set

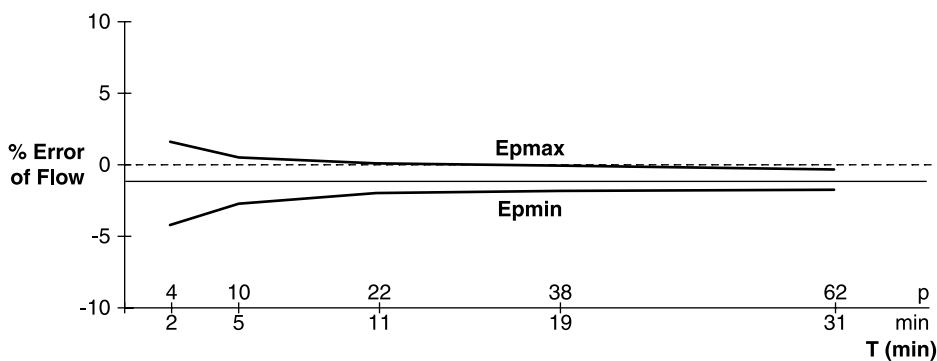

6.12 Safety Features and Fault Detection

6.12.1 Hardware Safety Features

Key hardware safety features include a watchdog timer circuit, motor driver and motor watchdog circuits, and a voltage detector circuit. Each safety circuit performs a unique function to insure the overall safety of the device.

Watchdog Timer Circuit

The microprocessor must send an appropriate signal to the watchdog circuit at least once per second. If the microprocessor does not, the watchdog circuit will time out and shut down the pump controller.

Watchdog timer circuitry is provided to monitor the status of the microprocessor and disable the motor and enable the audible alarm if the microprocessor fails to function properly. The microprocessor must strobe the watchdog circuit at least once every second in order to prevent the watchdog from performing its reset function. The reset output from watchdog circuit is a pulse output. This acts to “jump start” the microprocessor. This unique feature allows the microprocessor to test the watchdog circuit on every power up. By setting a flag in memory and not strobing the watchdog, the microprocessor can force a watchdog time-out. After being reset, the microprocessor checks the status flag to see if this was a time-out test. If so, the microprocessor continues normal power up activities. If the reset occurred when the microprocessor was not expecting it, the microprocessor traps the event, sounds the audible alarm and displays an error message on the LCD.

Motor Driver/Motor Watchdog Circuit

Motor drive circuitry is composed of a series of power FET transistors, passive components, and two voltage comparators. Built into the motor drive circuitry is an RC timer which times how long the motor runs each time it is turned on. If the motor runs for more than an average of 4 seconds, the circuit will time out and disable the motor. A unique feature of this circuit is that control lines to and from the microprocessor circuit allow the microprocessor to perform a complete functional test of the motor drive circuit without running the motor. The microprocessor performs this test function every several minutes to assure its continued functionality. An input from the watchdog circuit prevents motor operation if the watchdog timer expires.

Voltage Detector Circuit

Low voltage detection is performed by part of the Watchdog Circuit and by the microprocessor via software. Three low voltage levels are detected. The first two levels are detected by software and the third by hardware. The first level to be reached is the Low Battery Warning threshold which occurs when the battery voltage decays to a nominal value of 6.8 volts. An Analog to Digital Converter (ADC) built into the microprocessor allows the microprocessor, via software, to monitor the battery voltage. At the Low Battery Warning threshold, the microprocessor enables a periodic series of beeps and displays a low battery warning message on the LCD. As the battery voltage reaches a nominal value of 6.3 volts, the software disables delivery, places a battery depleted message on the LCD, and enables a constant two tone audible alarm. When the battery voltage decays to a nominal value of 5.6 volts, a hardware reset circuit is triggered which places the microprocessor in reset. This prevents ambiguous microprocessor operation when the battery voltage continues to decay. The hardware reset continues until the battery is completely discharged or until it is removed. Once the pump controller goes into low battery shutdown, only replacing the old battery with a new one will clear the condition.

6.12.2 Software Safety Features

Hardware-related Software Safety Features

Program Memory Check

At power up and at regular intervals thereafter, the program memory is tested by calculating a Cyclic Redundancy Code (CRC) on the program and then comparing it with the CRC stored with the program.

If the stored and calculated CRCs do not match, the software will turn on a continuous two-tone audible alarm and stop all drug delivery.

RAM Memory Check

At power up, the random access memory is checked. A particular bit pattern is written to and read from each address in the RAM. If the read data is different from the written data, the software will turn on a continuous two-tone audible alarm and stop all drug delivery.

Motor Circuit Check

At power up and at regular intervals thereafter, the motor circuit is checked to ensure that no power is being applied to the motor unless the motor is actually on. If the software detects power being applied to the motor at any other time, it will sound a continuous two-tone audible alarm and will no longer attempt to deliver medication. During every pump activation, the software checks to see whether the motor completes one activation. If the motor fails to turn, or fails to complete a cycle, the software will turn on a continuous two-tone audible alarm and stop all drug delivery.

Keyboard Encoder Check

Every time the software receives data from the keyboard encoder, it is checked. If the data is not of the proper form, the software will turn on a continuous two-tone audible alarm and stop all drug delivery.

6.13 Data Handling Software Safety Features

Data Stored in RAM

Before use, data associated with delivery and stored in RAM is tested by calculating a CRC on the data and then comparing it with the CRC stored with the data. If the stored and calculated CRCs do not match, the software will turn on a continuous two-tone audible alarm and stop all drug delivery.

Data Stored in EEPROM

Before use, data associated with delivery and stored in EEPROM is tested by calculating a CRC on the data and then comparing it with the CRC stored with the data. If the stored and calculated CRCs do not match, the software will turn on a continuous two-tone audible alarm and stop all drug delivery.

Data Stored in NOVRAM

Before use, data associated with delivery and stored in NOVRAM is tested by calculating a CRC on the data and then comparing it with the CRC stored with the data. If the stored and calculated CRCs do not match, the software will turn on a continuous two-tone audible alarm and stop all drug delivery.

Data Used in Calculations

Calculations on data used in some way to control the delivery of drug are performed redundantly.

The two calculated values are then compared. If the two values do not match, the software will turn on a continuous two-tone audible alarm and stop all drug delivery.

Timer Data Registers

The data stored in the timer control register is checked at regular intervals. If the data is not correct, the software will turn on a continuous two-tone audible alarm and stop all drug delivery.

6.14 Inspection Procedures

Smiths Medical MD recommends annual functional inspections on all CADD® pumps. Procedures contained in this section may be considered for inclusion in such inspections. Please note that the following information is not meant to be inclusive of all items which should be included in your program. The suggested procedures are only provided as a reference for your use.

NOTE: Persons performing the following tests and procedures should be familiar with the Deltec CADD-Prizm® pump. Please read the entire Operator's Manual before proceeding.

CAUTION: CADD® pumps are sealed units. A broken or damaged seal will, therefore, be considered conclusive evidence that the pump has been misused and/or altered, which voids any and all warranties. All service and repair of CADD® pumps must be performed by Smiths Medical MD or its authorized agents.

Visual Inspection

- Visually inspect the pump for any damage to the LCD, occlusion sensor seals, valves and expulsor, cassette hinge area, latch, lock, cassette sensors (3), keyboard, indicator lights, Power jack, Data In/Out jack, Air Detector, and housing.
- Check the battery door for proper operation. It should not be broken.

The mating tabs on the pump housing should not be broken.

- Examine the battery compartment for damage. If the battery contacts appear corroded, clean them with a cotton swab and isopropyl alcohol. If the battery contacts appear to be bent or pushed in, straightening may be possible with a small screwdriver or other suitable tool. Care must be taken so as not to damage the pump housing or to incur further damage to the contacts. The battery contacts should angle back toward the battery near the bottom of the contact.

Mechanical Inspection

- Press each key on the keyboard. Each key should have a distinctive dome feeling. The keys should not feel flat.
- Attach the battery door. The battery door should fit snugly in place when it is closed on the pump.
- Attach either a 50 or 100 ml Medication Cassette Reservoir or a CADD™ Administration Set to the pump. Check for smooth operation and a definite “feel” when the latch pulls the cassette firmly against the bottom of the pump. The mark on the latch should be aligned with the solid dot.
- Lock the cassette by inserting a key into the lock and turn counter-clockwise until the mark lines up with the solid dot. **NOTE:** The cassette must be locked in order to start the pump.

6.15 Testing Procedures

Functional Testing

Power Up Check

- Insert a battery in the pump and observe the LCD during power up. If “Error Detected” and five digits appear prior to the pump reviewing the current program settings, the pump has experienced an electrical or mechanical fault and should be returned for service. If the New Patient Marker screens appear, press  when the “Clear

Program and Start new patient” screen appears. If no error message is immediately shown, the pump has powered up normally. The pump should sequentially display all of the programmed values. The words “Self Test Complete” should appear, then the text “Power Up Successful” with six audible beeps. Continue with the Latch/Lock check.

Latch/Lock Check

- Attach a 50 or 100 ml Medication Cassette Reservoir or a CADD™ Administration Set to the pump. The mark on the latch should be aligned with the solid dot. The display should show that the cassette is latched.
- Lock the cassette by inserting a key into the lock and turning counterclockwise until the mark lines up with the solid dot. The display should show “Cassette Locked.”
- Unlock the cassette by inserting a key into the lock and turn clockwise until the mark lines up with the open dot. The display should show “Cassette Unlocked.”
- Unlatch the cassette by inserting a coin into the latch slot and turning clockwise until the mark lines up with the open dot. The display should show “Cassette Unlatched / Close Clamp to Prevent Free Flow.”

Cassette Sensor Check

- Attach a 50 or 100 ml Medication Cassette Reservoir to the pump. Latch the cassette to the pump. The display should show “Reservoir latched.” **NOTE:** The message displayed depends on the type of cassette attached.
- Lock the cassette by inserting a key into the lock and turning counterclockwise until the mark lines up with the solid dot. The display should show “Cassette Locked.”
- Unlock the cassette. The display should show “Cassette Unlocked.” Unlatch the cassette. The display should show “Cassette Unlatched / Close clamp to prevent free flow.”
- Remove the 50 or 100 ml Medication Cassette Reservoir and attach













a CADD™ Administration Set to the pump. Latch the cassette to the pump. The display should show “Admin Set Latched.”

- Lock the cassette by inserting a key into the lock and turning counterclockwise until the mark lines up with the solid dot. The display should show “Cassette Locked.”
- Unlock the cassette. The display should show “Cassette Unlocked.” Unlatch the cassette. The display should show “Cassette Unlatched / Close clamp to prevent free flow.”









The following three checks (LCD, motor and gear train, and Reservoir Volume is Zero alarm) should be performed in the sequence shown.

LCD Check







- Remove and reinsert the battery. After a few seconds, the LCD will display all off pixels (dots) followed by all on pixels. Examine the LCD for missing dark or light pixels.
- Program the pump to the following parameters:

Units:	Milligrams
Concentration:	1.0 mg/ml
Continuous Rate:	30.0 mg/hr
Demand Dose:	0.0 mg
Set Delivery Limit:	“No Limit”
Reservoir Volume:	2.0 ml
Given:	0.0 mg (make sure Given is turned on in Reports in the Biomed Toolbox - see Section 5. Press  until the Given screen appears, then press  to clear)
- Press  until Reservoir Volume is displayed on the LCD. Press  or  until 2.0 ml is displayed. Then press . Select Milligrams for units and press . Select the Concentration of 1.0 mg and press . Select the Continuous Rate of 30.0 mg/hr, then press . Select the Demand Dose of 0.0 mg, then press . Press  until the Given screen appears, then clear by pressing .





Motor and Gear Train Check

- Attach either a 50 or 100 ml Medication Cassette Reservoir or CADD™ Administration Set filled with water to the pump. Latch and lock the cassette.
- Press . Now press and continue to hold the  key. The pump should begin to prime. While priming the pump, listen to the motor for excessive noise or grinding sounds. Continue to hold the  key for ten double activations, or 1.0 ml, and then release the  key. The display should show “Continue Priming? Press  or . Press . Then press  twice until the Reservoir Volume screen appears. The Reservoir Volume should show 1.0 ml.

Reservoir Volume is Zero Alarm Check

- Press  again. Repeat priming by pressing and holding the  key. The pump should prime ten double activations and then stop. The pump will alarm and display “Reservoir Volume is Zero.” Press .
- Reprogram the Reservoir Volume to 1.0 ml. Press  until Reservoir Volume is displayed on the LCD. Press  or  until 1.0 ml is displayed. Then press .

Starting/Stopping the Pump

- Check the  key by pressing it. “Start the Pump?” should be displayed. Press . The display should show “Starting Pump” followed by a review of the programmed parameters. The main screen should appear with “RUNNING” in the display, and the green LED indicator light should blink every 3 seconds.
- To stop the pump, press . When the message “Stop the Pump?” appears, press .

Activation Timing Check

- Check the activation timing by programming the pump with the following values:

Units: Milligrams

Concentration:	1.0 mg/ml
Continuous Rate:	30.0 mg/hr
Demand Dose:	0.0 mg
Set Delivery Limit:	“No Limit”
Reservoir Volume:	1.0 ml
Given:	0.0 mg (make sure Given is turned on in Reports in the Biomed Toolbox - see Section 5. Press REPORTS until the Given screen appears, then press ENTER to clear)

- Press **STOP START**. Press **YES**. “Starting Pump” should appear on the display. The pump should sequentially display all of the programmed values. Start a timer at the first motor activation.
- Count the activations. One activation should occur every twelve seconds. Approximately one minute fifty seconds (1:50) and ten activations later, the Reservoir Volume alarm should occur. The display should show “Reservoir Volume is zero” with a Given of 1.0 mg.



Remote Dose Cord Check



- Programming the pump with the following values:

Units:	Milligrams
Concentration:	1.0 mg/ml
Continuous Rate:	0.0 mg/hr
Demand Dose:	1.0 mg
Demand Dose Lockout:	0 hrs 5 min
Set Delivery Limit:	“No Limit”
Reservoir Volume:	10.0 ml
Dose Counters:	0/0 (Make sure the Dose Counters are turned on Reports in the Biomed Toolbox - see Section 5. Press REPORTS until Dose Counters screen appears, then





Given:

press  to clear)



0.0 mg (make sure Given is turned on in Reports in the Biomed Toolbox - see Section 5. Press  until the Given screen appears, then press  to clear)

- Press . Press . The pump should sequentially display all of the programmed values.
- After RUNNING appears on the display, press the button on the Remote Dose cord. The pump should make ten double activations. After ten double activations, the display should show a Reservoir Volume of 9.0 ml. Press the button on the Remote Dose cord two more times within the next 5 minutes. The pump should not deliver and the message “Dose Not Delivered, Dose Locked Out” should be displayed.

Doses Given and Doses Attempted Check

- Stop the pump by pressing , then . Press  until the Dose Counters screen is displayed. The display should show 1/3. (If the above steps have not been followed exactly, different values may appear.)
- Press . The display should now show 0/0.

GIVEN Check

- Press  until the Given screen appears. The display should now show 1.0 mg. (If the above steps have not been followed exactly, a different value may appear.)
- Press . The display should now show 0.0 mg.

6.16 Occlusion Pressure Range Tests

Occlusion Pressure Range Test I

Description:

Pressure is generated by activating the pumping mechanism with an attached filled, clamped Medication Cassette Reservoir. The pump is started and a Demand Dose is given until the high pressure alarm sounds.

Equipment needed:

50 or 100 ml Medication Cassette Reservoir containing distilled water.

Procedure:

1. Insert a battery and wait for the pump to power up.
2. Attach a Medication Cassette Reservoir containing distilled water to the pump. Latch and lock the cassette.
3. Prime the tubing. The tubing should be filled with fluid to the end of the luer lock connector. The system *must* be free from air bubbles for this test.
4. Close the clamp on the distal end of the tubing near the female luer of the Medication Cassette Reservoir.
5. Program the pump to the following parameters:

Units:	Milligrams
Concentration:	1.0 mg/ml
Continuous Rate:	0.0 mg/hr
Demand Dose:	1.0 mg
Demand Dose Lockout:	0 hrs 5 min
Set Delivery Limit:	“No Limit”
Reservoir Volume:	10.0 ml
Dose Counters:	0/0 (Make sure the Dose Counters are turned on Reports in the Biomed Toolbox - see Section 5. Press REPORTS until Dose Counters screen appears, then press ENTER to clear)

Given: 0.0 mg (make sure Given is turned on in Reports in the Biomed Toolbox - see Section 5. Press **REPORTS** until the Given screen appears, then press **ENTER** to clear)

6. Start the pump. When the pump is running, activate a Demand Dose, noting when the high pressure alarm is activated.
7. The pump should alarm when the pump delivers between 1 and 2 activations.

Occlusion Pressure Range Test II

Description:

An adjustable metered pressure source is connected to the Medication Cassette Reservoir tubing. The pressure is slowly increased until the high pressure alarm sounds.

Equipment needed:

Pressure gauge, 30 psi \pm 1 psi [2.07 bar \pm 0.07 bar]

Pressure vessel, partially filled with water

Pressure regulator, 30 psi [2.07 bar]

50 or 100 ml Medication Cassette Reservoir containing water

Procedure:

1. Insert a battery and wait for the pump to power up.
2. Attach a Medication Cassette Reservoir to the pump. Latch and lock the cassette.

NOTE: The pressure from the source must be zero when the cassette is attached.

3. Assemble the apparatus as shown.

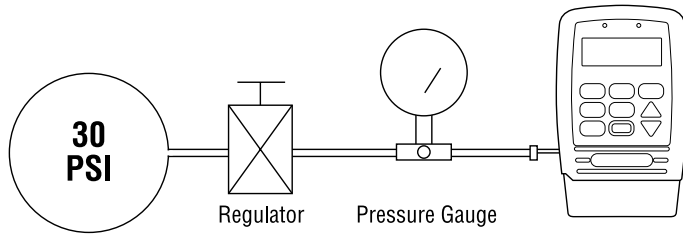

4. Connect the Medication Cassette Reservoir outlet tube to the metered pressure source.

NOTE: Do not use a CADD™ Extension Set with Anti-Siphon Valve.

5. Start the pump and run at 30 ml/hr.
6. Slowly increase the backpressure, noting when the high pressure alarm is activated.

NOTE: The pressure may be increased rapidly to 8 psi [0.55 bar], after which the pressure should be increased at 3 psi/min [0.21 bar/min] or less until the alarm sounds.

7. The high pressure alarm should sound between 9 and 27 psi (18 ± 9 psi) [between 0.62 and 1.93 bar (1.24 ± 0.62 bar)].

CAUTION: At the completion of the test, the pressure must be reduced to zero before detaching the cassette from the pump; otherwise, the cassette may rupture. Safety glasses should be worn while conducting or observing this test.

6.17 Accuracy Tests

Gravimetric Accuracy Testing

Description:

A Medication Cassette Reservoir is partially filled with water and weighed. The cassette is then attached to the pump and the pump is set to deliver a certain amount of water. The cassette is then removed and weighed again. The amount of water delivered is compared to the amount that the pump should have delivered.

Nominal system accuracy is given in the technical specifications section for the pump. That is, under the test conditions described below, the accuracy of the pump and Medication Cassette Reservoir will be nominal with a 90% confidence level. The nominal test conditions are as follows: degassed water at $25 \pm 5^\circ\text{C}$ without back pressure.

Equipment needed:

50 or 100 ml Medication Cassette Reservoir with attached CADD™ Extension Set **OR**

50 or 100 ml Medication Cassette Reservoir with flow stop feature with attached CADD™ Extension Set (reorder numbers start with 21-73xx)

50 or 60 ml syringe

A balance accurate to 0.1 g

40 ml of room temperature water

Procedure:

1. Fill the 50 or 60 ml syringe with 40 ml of water. Transfer the water into a Medication Cassette Reservoir.
2. Remove any air from the Medication Cassette Reservoir by aspirating the air with the syringe. Attach the CADD™ Extension Set. Prime the tubing so it is filled with fluid to the end of the extension set luer lock.
3. Secure the clamp as close to the extension set luer lock connector as possible. This should assure a minimum water loss from the tubing when the syringe is removed.
4. Weigh the entire Medication Cassette Reservoir/extension set assembly and record the weight. This is the **predelivery weight**. (This weight includes the empty Medication Cassette Reservoir,

extension set, and weight of the water.)

5. Attach the cassette to the pump. Program the Reservoir Volume to 20 ml. Now press **ENTER**. This value is the **intended delivery volume**. (One ml of water at 20°C weighs 1 gram.) Open the clamp.
6. With the pump in Lock Level 0, program a continuous rate of 0 ml/hr and a dose of 1.0 mg (but do not deliver a Demand Dose). Start the pump and deliver a Clinician Bolus of 20 ml. Press **PRIME BOLUS** and press **NO** until ******* appears then press **ENTER**. Press **NO** again to enter 20 ml as the Clinician Bolus, and then press **ENTER**. The pump will deliver 20 ml.
7. Again, secure the clamp as close as possible to end of the extension set luer lock connector. Remove the cassette from the pump and weigh the entire Medication Cassette Reservoir/extension set assembly. This is the **postdelivery weight**.
8. Calculate the difference in weight between the predelivery weight and the postdelivery weight. This is the **weight of the amount delivered**.
9. Find the difference between the actual delivery volume and the intended delivery volume. This is the **inaccuracy volume**.
10. Divide the inaccuracy volume by the intended delivery volume and multiply by 100. This is the **accuracy error percentage**.
11. If the accuracy error percentage is greater than $\pm 6\%$, repeat the test with a new Medication Cassette Reservoir. If the pump fails a second time, call Smiths Medical MD, Inc. or Smiths Medical International Ltd.

Example:	Predelivery Weight:	61.1 g
	Postdelivery Weight:	– 41.6 g
	Weight of Amount Delivered:	= 19.5 g
	Volume of Amount Delivered:	19.5 ml
	Intended Delivery Volume:	– 20.0 ml
	Inaccuracy Volume:	= – 0.5 ml
	Inaccuracy Volume:	– 0.5 ml
	Intended Delivery Volume:	÷ 20.0 ml
	Accuracy Error:	= – 0.025
	Accuracy Error:	– 0.025
		× 100.00
	Accuracy Error Percentage:	= – 2.5%

Volumetric Accuracy Testing

Description:

A predetermined amount of water is delivered into a collection device such as a burette or graduated cylinder. The amount of water delivered is compared to the amount that the pump should have delivered.

Nominal system accuracy is given in the technical specifications section for the pump. That is, under the test conditions described below, the accuracy of the pump and Medication Cassette Reservoir will be nominal with a 90% confidence level. The nominal test conditions are as follows: degassed water at $25 \pm 5^\circ\text{C}$ without back pressure.

Equipment needed:

50 or 100 ml Medication Cassette Reservoir with attached CADD™ Extension Set **OR**

50 or 100 ml Medication Cassette Reservoir with flow stop feature with attached CADD™ Extension Set (reorder numbers start with 21-73xx)

50 or 60 ml syringe

A fluid collection device such as a burette or a Class A, 25 ml capacity graduated cylinder

40 ml of room temperature water

Procedure:

1. Fill the 50 or 60 ml syringe with 40 ml of water. Transfer the water into a Medication Cassette Reservoir.
2. Remove any air from the Medication Cassette Reservoir by aspirating the air with the syringe. Attach the CADD™ Extension Set. Prime the tubing so it is filled with fluid to the end of the extension set luer lock.
3. Attach the end of the extension set to the fluid collection device.
4. Attach the cassette to the pump. Program the Reservoir Volume to 20 ml. This is the **intended delivery volume**. Open all clamps.
5. Program a continuous rate of 0.0 ml/hr and a demand dose of 1.0 ml (but do not deliver a demand dose). Start the pump and deliver a clinician activated bolus of 20 ml.
6. When delivery is complete, record the volume of fluid delivered.

This is the **actual delivery**.

7. Find the difference between the actual delivery volume and the intended delivery volume. This is the **inaccuracy volume**.
8. Divide the inaccuracy volume by the intended delivery volume and multiply by 100. This is the **accuracy error percentage**.
9. If the accuracy error percentage is greater than $\pm 6\%$, repeat the test with a new Medication Cassette Reservoir. If the pump fails a second time, call Smiths Medical MD, Inc. or Smiths Medical International Ltd.

Example:	Actual Delivery Volume:	19.5 ml
	Intended Delivery Volume:	– 20.0 ml
	Inaccuracy Volume:	= – 0.5 ml
	Inaccuracy Volume:	– 0.5 ml
	Intended Delivery Volume:	÷ 20.0 ml
	Accuracy Error:	= – 0.025
	Accuracy Error:	– 0.025
		× 100.00
	Accuracy Error Percentage:	= – 2.5%

Index

Bold page numbers indicate figure references

A

AC Adapter, 7, 91, 92, 107
 accuracy, 108
 accuracy tests, 115, 130
 gravimetric, 130
 volumetric, 132
 Air Detector, 4, 6, 15, 42, 88, 89, 110
 changing, 66, 88
 inserting tubing into, 44
 status, 32, 37
 Turning On/Off, 65
 alarms, 91, 106
 analgesics, 1
 anesthetics, 1
 Auto Review, 81
 AutoLock, 10, 38, 75
 viewing/changing, 75

B

battery, 9 volt, 13, 89
 installing, 14
 battery compartment, 4, 7
 battery contacts, cleaning, 100
 battery life, 14
 Biomed Toolbox, 12, 67
 accessing, 67
 Air Detector, 88, 112
 Auto Review, 81
 AutoLock, 75, 110
 custom Clinician Bolus Code, 77, 111
 custom concentrations, 68, 71, 110
 custom Lock Level Code, 77, 111
 custom main screen, 80, 111
 custom Reports, 81, 111
 Date, 12, 80, 111
 Delivery Limit, 70, 110

Dosing Limit, 69
 Epidural Mode, 12
 key beeps, 72, 110
 Maximum Delivery Rate, 71, 110
 New Patient Marker, 84, 112
 PM Reminder, 76, 111
 Program Limits, 70
 programming units, 79
 Pump Stopped Alarm, 73
 Res Vol Alert, 72, 110
 Res Vol Empty Alarm, 73
 Time, 12
 Titration limit, 74, 110
 Units Location, 12, 62, 111
 Units Selection, 78
 Upstream Sensor On/Off, 87, 112
 Biomed Toolbox Code, 10

C

cassette, 4, 7
 attaching, 39
 removing, 38
 cassette latch, 4, 7
 Cassette/Keypad lock, 4, 8, 18
 cleaning the pump, accessories, 99
 Clear ing records & lockouts in power
 up, 15
 Clearing program in power up, 16
 Clearing Records and Lockouts, 15, 25
 Clearing the Program, 16, 26
 Clinician Bolus, 11, 102, 103, 104, 109
 starting, 53
 stopping, 57
 Clinician Bolus Code, 10, 89
 customizing, 77, 89
 Concentration, 11, 30, 68, 89, 109
 programming, 34
 Continuous Rate, 11, 30, 102, 109
 programming, 34
 Custom Reports, 12, 81
 Delivery Log, 12, 24, 83
 on/off, 83
 Dose Counters, 12, 21, 82
 on/off, 82

Doses Hour by Hour, 12, 22
 Event Log, 12, 25
 on/off, 84
 Given, 12, 22
 New Patient Marker, 12
 on/off, 84
 Pain Scale, 12, 23, 83
 on/off, 83
 Pain Scale Log, 12, 24, 83
 on/off, 83
 Patient Review, 12, 23
 on/off, 83
 Units Location, 78
 changing, 78

D

Data In/Out jack, 4, 6
 Date, 12
 changing, 64, 80
 Delivery Limit, 31, 36, 70, 109
 programming, 36, 70
 Delivery Log, 12, 24, 83
 viewing, 24
 Delivery Modes, 15, 28
 Demand Dose, 11, 21, 31, 102, 103, 104, 109
 programming, 34
 starting, 55
 stopping, 57
 Demand Dose Lockout, 31, 109
 programming, 35
 Dose Counters, 12, 82
 clearing, 21
 Doses Hour by Hour, 12, 82
 viewing, 22
 Dosing Limit, 69
 Max Doses Per Hour, 31
 Downstream Occlusion Sensor, 8

E

epidural administration, 1, 12
 Epidural Mode

 turning on/off, 62
 Event Log, 12, 25, 83
 viewing, 25

G

Given, 12, 22, 109
 clearing, 22

I

Indicator lights, 4, 5
 inspection procedures, 120

K

Key beeps
 turning on/off, 72
 keypad, keys, 4, 5

L

Lock Level Code, 10, 89
 customizing, 76, 89
 Lock Levels, 10, 11, 12, 110
 Changing, 18

M

magnetic resonance imaging, 101
 main screen, 9, 20, 33, 80
 customizing, 80
 Max Doses Per Hour, 31, 35
 Maximum Delivery Rate, 71
 programming, 71

N

New Patient Marker Function, 12, 25, 84
 Clearing Records and lockouts, 15, 25, 84
 Clearing the Program, 16, 26, 85

O

Options, 12
 accessing, 59
 Air Detector On/Off, 65
 Date, 64
 Epidural Mode, 61
 Lock Level, 60
 Time, 63
 Units, 62

P

Pain Scale, 12, 23, 83
 programming, 23
Pain Scale Log, 12, 24, 83
 viewing, 24
Patient Review, 12, 23, 82
 programming, 23
PM Reminder, 76
 programming, 76
Polemount bracket, 4, 7
power jack, 4, 6
power up, 15
 clearing program, 16
 clearing records, lockouts, 15
pressure tests, 127
Priming, 42
Printed Reports, 11, 89, 112
Program Limits, 70
 programming, 19, 20
Pump indicators On/Off, 51, 52
Pump Stopped Alarm, 73

R

radiation, exposure to, 101
Remote Dose Cord, 47
 attaching, 47
 removing, 47
REPORTS Key, 21
Res Vol Empty Alarm, 73
Reservoir Volume, 8, 32, 109
 programming, 37
 resetting, 41, 58

S

safety features, 117
 hardware, 117
 software, 118
Screen Maps, 113
 Biomed Toolbox Menu Screens, 114
 Custom Reports Menu Screens, 114
 Options Menu Screens, 113
 Programming Screens, 113
Security Codes, 10
 Biomed Toolbox Code, 10
 Clinician Bolus Code, 10
 customizing, 10
 Lock Level Code, 10
software version, 15
Specifications, 106
 Biomed Toolbox, 110
 Delivery, 109
 general, 106
 Options, 110
starting the pump, 48, 51
stopping the pump, 51
Subarachnoid Administration, 1
system definition, 108

T

testing procedures, 121
Time, 12, 110
 changing, 63
Titration, 49, 74
 while pump is running, 49
Titration Limit
 programming, 73, 74

U

ultrasound, 101
Units, 11, 12, 33, 79, 109
 changing, 62
Units Selection, 78
Upstream Occlusion Sensor, 8, 87
 turning on/off, 87

Limited Warranty

Smiths Medical MD, Inc. (the “Manufacturer”) warrants to the Original Purchaser that the Deltec CADD-Prizm® Model 6101 Ambulatory Infusion Pump (the “Pump”), not including accessories, shall be free from defects in materials and workmanship under normal use, if used in accordance with this Operator’s Manual, for a period of two years from the actual date of sale to the Original Purchaser. THERE ARE NO OTHER WARRANTIES.

This warranty does not cover normal wear and tear and maintenance items, and specifically excludes batteries, administration sets, extension sets or any other accessory items or equipment used with the Pump.

Subject to the conditions of and upon compliance with this Limited Warranty, the Manufacturer will repair or replace at its option without charge (except for a minimal charge for postage and handling) any Pump (not including accessories) which is defective if a claim is made during such two-year period.

The following conditions, procedures, and limitations apply to the Manufacturer’s obligation under this warranty:

A. Parties Covered by this Warranty: This warranty extends only to the Original Purchaser of the Pump. This warranty does not extend to subsequent purchasers. The Original Purchaser may be a patient, medical personnel, a hospital, or institution which purchases the Pump for treatment of patients. The Original Purchaser should retain the invoice or sales receipt as proof as to the actual date of purchase.

B. Warranty Performance Procedure: Notice of the claimed defect must be made in writing or by telephone to the Manufacturer as follows: Customer Service Department, **Smiths Medical MD, Inc.**, 1265 Grey Fox Road, St. Paul, MN 55112 USA, (800) 426-2448 (USA, Canada) or **Smiths Medical International Ltd.** WD24 4LG, UK, +44 (0)1923 246434. Notice to the Manufacturer must include date of purchase, model and serial number, and a description of the claimed defect in sufficient detail to allow the Manufacturer to determine and facilitate any repairs which may be necessary. **AUTHORIZATION MUST BE OBTAINED PRIOR TO RETURNING THE PUMP.** If authorized, the Pump must be properly and carefully packaged and returned to the Manufacturer, postage prepaid. Any loss or damage during shipment is at the risk of the sender.

C. Conditions of Warranty: The warranty is void if the Pump has been 1) repaired by someone other than the Manufacturer or its authorized agent; 2) altered so that its stability or reliability is affected; 3) misused; or, 4) damaged by negligence or accident. Misuse includes, but is not limited to, use not in compliance with the Operator’s Manual or use with nonapproved accessories. The Pump is a sealed unit, and the fact that the seal has been broken will be considered conclusive evidence that the Pump has been altered or

misused. Removal or damage to the Pump’s serial number will invalidate this warranty.

D. Limitations and Exclusions: Repair or replacement of the Pump or any component part thereof is the **EXCLUSIVE** remedy offered by the Manufacturer. The following exclusions and limitations shall apply:

1. No agent, representative, or employee of the Manufacturer has authority to bind the Manufacturer to any representation or warranty, expressed or implied.
2. **THERE IS NO WARRANTY OF MERCHANTABILITY OR FITNESS OR USE OF THE PUMP FOR ANY PARTICULAR PURPOSE.**
3. The Pump can only be used under the supervision of medical personnel whose skill and judgment determine the suitability of the Pump for any particular medical treatment.
4. All recommendations, information, and descriptive literature supplied by the Manufacturer or its agents are believed to be accurate and reliable, but do not constitute warranties.

E. Computer Program License:

1. The Pump is intended to be used in conjunction with a particular Licensed Computer Program supplied by Manufacturer and use of any other program or unauthorized modification of a Licensed Computer Program shall void Manufacturer’s warranty as set forth above.
2. The Original Purchaser and any users authorized by the Original Purchaser are hereby granted a nonexclusive, nontransferable license to use the Licensed Computer Program only in conjunction with the single Pump supplied by Manufacturer. The Licensed Computer Program is supplied only in machine-readable object code form and is based upon Manufacturer’s proprietary confidential information. No rights are granted under this license or otherwise to decompile, produce humanly readable copies of, reverse engineer, modify or create any derivative works based upon the Licensed Computer Program.
3. All other terms and conditions of this Limited Warranty shall apply to the Licensed Computer Program.

The Manufacturer disclaims responsibility for the suitability of the Pump for any particular medical treatment or for any medical complications resulting from the use of the Pump. The Manufacturer shall not be responsible for any incidental damages or consequential damages to property, loss of profits, or loss of use caused by any defect or malfunction of the Pump.

This warranty gives the Original Purchaser specific legal rights, and the Original Purchaser may have other legal rights which may vary from state to state.

CADD, CADD-Prizm, and the Medication Cassette Reservoir design mark are trademarks of the Smiths Medical family of companies. The symbol ® indicates it is registered in the U.S. Office of Patent and Trademarks and certain other countries.

All other names and marks mentioned are trade names, trademarks or service marks of their respective owners.

Covered by one or more of the following: U.S. Patent Nos. 4,559,038; 4,565,542; 4,650,469; 5,181,910; 5,338,157; 5,364,242; 5,485,408; 5,531,697; 5,531,698; 5,538,399; 5,540,561; 5,564,915; 5,567,136; 5,567,119; 5,695,473; other patents pending.

Smiths Medical MD, Inc.
1265 Grey Fox Road
St. Paul, Minnesota 55112, U.S.A.
1 800.426.2448
+1 651.633.2556

EC REP

Smiths Medical International Ltd.,
WD24 4LG UK
+44 (0)1923 246434
www.smiths-medical.com

© 2004 Smiths Medical family of companies.
... ed.

smiths

CE
0473

2004-12
40-4938-51C



To Purchase, Visit Avobus.com or call [1-800-674-3655](tel:1-800-674-3655)